

OXYGEN 3000 PLUS | 16 FADERS



OXYGEN 3000 PLUS | 12 FADERS



OXYGEN 3000 PLUS | 08 FADERS

OXYGEN 3000 PLUS

(Rev. 1.0-ENG)

SUMMARY

| | |
|---|-----------|
| SUMMARY | 2 |
| SAFETY WARNINGS/ISTRUZIONI PER LA SICUREZZA | 4 |
| PREFACE..... | 4 |
| SAFETY WARNINGS..... | 5 |
| CONSIGNES DE SÉCURITÉ IMPORTANTES..... | 7 |
| ISTRUZIONI IMPORTANTI PER LA SICUREZZA | 9 |
| WICHTIGE SICHERHEITSHINWEISE..... | 12 |
| INSTRUCCIONES IMPORTANTES DE SEGURIDAD..... | 14 |
| UNPACKING AND INSPECTION | 16 |
| 1. First Installation Recommendations | 17 |
| POWER SUPPLY..... | 17 |
| INSTALLATION NOTE AND FIRST STEP | 18 |
| FIRST CONNECTION | 19 |
| INTRODUCTION | 20 |
| 2. GENERAL DESCRIPTION | 22 |
| DIMENSIONS (8 PHYSICAL FADERS)..... | 22 |
| DIMENSIONS (12 PHYSICAL FADERS)..... | 23 |
| DIMENSIONS (16 PHYSICAL FADERS)..... | 24 |
| TALKBOX DIMENSIONS | 25 |
| INPUT CONNECTIONS | 26 |
| OUTPUT CONNECTIONS | 27 |
| TALKBOX CONNECTIONS | 28 |
| 3. SURFACE | 29 |
| 3.1. CHANNEL CONTROLS | 30 |
| 3.1.1. CHANNEL DISPLAY..... | 31 |
| 3.1.2. GAIN..... | 31 |
| 3.1.3. F1 & F2 | 32 |
| 3.1.4. PGM, SUB, AUX1, AUX2 | 32 |
| 3.1.5. FADER..... | 33 |
| 3.1.6. FADER LED BAR | 33 |
| 3.1.7. ON/START..... | 34 |
| 3.1.8. PFL..... | 34 |
| 3.2. SPECIAL FUNCTION BUTTONS..... | 36 |
| 3.2.1. SNAPSHOTS | 36 |
| 3.2.2. FUNCTIONS | 36 |
| 3.2.3. TALKBACK..... | 37 |
| 3.3. MONITORS SECTION | 37 |
| LOUDSPEAKERS & HEADPHONES..... | 37 |
| 3.4. MENU CONTROL | 40 |
| BUTTONS & DISPLAY 7" TFT | 40 |
| 3.5. OUTPUTS DISPLAY..... | 42 |
| 4. MENU | 43 |
| 4.1. AUDIO | 43 |
| 4.1.1. SETTINGS..... | 43 |
| INPUT MODE..... | 43 |
| SURFACE MODE | 44 |

| | |
|--|-----------|
| FADER SETTINGS | 44 |
| VJ PRO MODE..... | 45 |
| 4.1.2. <i>INPUTS</i> | 46 |
| MIC (MIC-1 TO MIC-10)..... | 46 |
| ADV. SETTINGS..... | 49 |
| MIC AUTOMIX..... | 54 |
| MONO / STEREO | 54 |
| USB-1, USB-2..... | 56 |
| DIGITAL AES/EBU | 57 |
| DANTE* | 57 |
| PHONE / TELCO / BT (BLUETOOTH) | 58 |
| INTEGRATED HYBRID LINE | 59 |
| EXTERNAL TELCO DEVICE | 60 |
| ADDITIONAL TELCO LINES..... | 61 |
| BLUETOOTH | 63 |
| STREAMER..... | 63 |
| TONE GEN. | 64 |
| 4.1.3. <i>OUTPUTS</i> | 64 |
| ANALOG & DIGITAL OUTPUTS..... | 65 |
| DANTE OUT | 65 |
| MONITOR (SPK & HDP) | 66 |
| 4.1.4. <i>CHANNELS</i> | 67 |
| <i>ENABLE VIRTUAL CHANNELS</i> | 67 |
| 4.2. <i>SNAPSHOT</i> | 68 |
| 4.3. <i>GENERAL SET.</i> | 68 |
| 4.3.1. <i>GPIO</i> | 68 |
| 4.3.2. <i>COMMUNICATIONS</i> | 69 |
| TCP-IP..... | 69 |
| TIME & DATE..... | 69 |
| 4.3.3. <i>ACCESS CODE</i> | 70 |
| 4.3.4. <i>LIGHT & DISPLAY</i> | 71 |
| BUTTON LIGHT | 71 |
| 4.3.5. <i>SMART KEYS</i> | 72 |
| 4.3.6. <i>ONAIR TRIGGERS</i> | 72 |
| 4.4. <i>SERVICE</i> | 73 |
| 4.4.1. <i>CONFIGURATION</i> | 73 |
| FACTORY RESET..... | 73 |
| SAVE..... | 73 |
| RESTORE..... | 73 |
| 4.4.2. <i>SOFTWARE</i> | 74 |
| 4.4.3. <i>LOGS</i> | 75 |
| 4.4.4. <i>WEB LOGIN</i> | 75 |
| 4.4.5. <i>DIAGNOSTIC</i> | 75 |
| 4.4.6. <i>SURFACE LOCK</i> | 76 |
| 4.4.7. <i>KICK REMOTE CLIENT</i> | 76 |
| + 187-RJ45-MIC | 77 |
| + 188-RJ45-TELCO | 78 |
| + 189-RJ45-LINE-IN | 79 |
| + 190-RJ45-LINE-OUT | 80 |
| TECH SPECS | 81 |
| WEEE DIRECTIVE – INFORMATIVA RAEE | 85 |
| WARRANTY | 86 |

SAFETY WARNINGS/ISTRUZIONI PER LA SICUREZZA

SAFETY WARNINGS

CONSIGNES DE SÉCURITÉ IMPORTANTES

ISTRUZIONI IMPORTANTI PER LA SICUREZZA

WICHTIGE SICHERHEITSHINWEISE

INSTRUCCIONES IMPORTANTES DE SEGURIDAD

(Rel. 6.2.0.2)

PREFACE

For your safety and to prevent the warranty from being accidentally invalidated, please read carefully all the texts marked with the Warning Symbols



The information contained in this manual is subject to change without notice and does not constitute a commitment by the seller.

The manufacturer will not be liable for any loss or damage resulting from the use of information or any errors contained in this manual or resulting from any erroneous operation or hardware failure contained in the product.

It is recommended that any repair and maintenance of the product be carried out by the manufacturer or its authorized agents. The manufacturer assumes no responsibility for any loss or damage caused by service, maintenance, or repair by unauthorized personnel.

SAFETY WARNINGS

The installation and servicing instructions in this manual are for use by qualified personnel only.

Read All Instructions. All safety and operating instructions must be read before operating the product. They also must be retained for future reference, as it contains many useful hints for determining the best combination of equipment settings for Yr particular application.

Heed All Warnings. All warnings on the product and those listed in the operating instructions must be adhered to.

Heat. This product must be situated away from any heat sources such as radiators or other products (including power amplifiers or transmitters) that produce heat.

Power Sources. This product must be operated from the type of power source indicated on the marking label and in the installation instructions. If you are not sure of the type of power supplied to your facility, consult your local power company. Make sure the AC main voltage corresponds to that indicated in the technical specifications. If a different voltage (ex. 110/115 VAC) is available, open the equipment closure and set the voltage switch on the main supply circuit, located behind the AC socket.

Power Cord Protection. Power supply cords must be routed so that they are not likely to be walked on or pinched by items placed upon or against them. Pay particular attention to the cords at AC wall plugs and convenience receptacles, and at the point where the cord plugs into the product.

Use only with a cart, stand, tripod, bracket, or table specified by the manufacturer, or sold with the apparatus. When a cart is used, use caution when moving the cart/apparatus combination to avoid injury from tip-over.

Lightning. For added protection for this product during a lightning storm, or when it is left unattended and unused for long periods, unplug it from the AC wall outlet and the audio connections. This will prevent damage to the product due to lightning and power-line surges.

Installation. Configuration and installation should only be carried out by a competent installation engineer.

Cabling. Using high-quality wires, well-protected. Make sure the cable is integrity.



This symbol alerts you to the presence of dangerous voltage inside the closure – voltage that may be sufficient to constitute a risk of shock. Do not perform any servicing other than that contained in the operating instructions. Refer all servicing to qualified personnel.



The exclamation point within an equilateral triangle is intended to alert the user to the presence of important operating and maintenance (servicing) instructions in the literature accompanying the appliance.



Do not change the voltage setting or replace the mains fuse without first turning the unit off and unplugging the mains cord.



Make sure the AC main voltage corresponds to that indicated in the technical specifications.

THIS APPARATUS MUST BE EARTHED!



To avoid the risk of fire, use the correct value fuse, as indicated on the label stuck on the right side of the unit.



This apparatus uses a single-pole main switch and does therefore not separate the unit completely from the main power. To completely separate from mains power (f.i. in the event of danger) unplug the mains power cord. As the MAINS plug is the disconnect device, the disconnect device shall remain readily operable.

CONSIGNES DE SÉCURITÉ IMPORTANTES

Lire ces consignes.

Conserver ces consignes.

Observer tous les avertissements.

Suivre toutes les consignes.

Ne pas utiliser cet appareil à proximité de l'eau.

Ne pas obstruer les ouvertures de ventilation. Installer en respectant les consignes du fabricant.

Ne pas installer à proximité d'une source de chaleur telle qu'un radiateur, une bouche de chaleur, un poêle ou d'autres appareils (dont les amplificateurs) produisant de la chaleur.

Ne pas annuler la sécurité de la fiche de terre, la troisième branche est destinée à la sécurité. Si la fiche fournie ne s'adapte pas à la prise électrique, demander à un électricien de remplacer la prise hors normes.

Protéger le cordon d'alimentation afin que personne ne marche dessus et que rien ne le pince, en particulier aux fiches, aux prises de courant et au point de sortie de l'appareil.

Utiliser uniquement les accessoires spécifiés par le fabricant.

Utiliser uniquement avec un chariot, un support ou une table spécifié par le fabricant ou vendu avec l'appareil. Si un chariot est utilisé, déplacer l'ensemble chariot–appareil avec précaution afin de ne pas le renverser, ce qui pourrait entraîner des blessures.

Débrancher l'appareil pendant les orages ou quand il ne sera pas utilisé pendant longtemps.

Confier toute réparation à du personnel qualifié. Des réparations sont nécessaires si l'appareil est endommagé d'une façon quelconque, par exemple: cordon ou prise d'alimentation endommagé, liquide renversé ou objet tombé à l'intérieur de l'appareil, exposition de l'appareil à la pluie ou à l'humidité, appareil qui ne marche pas normalement ou que l'on a fait tomber.

NE PAS exposer cet appareil aux égouttures et aux éclaboussures. Ne pas poser des objets contenant de l'eau, comme des vases, sur l'appareil.



Ce symbole indique la présence d'une tension dangereuse dans l'appareil constituant un risque de choc électrique.



Ce symbole indique que la documentation fournie avec l'appareil contient des instructions d'utilisation et d'entretien importantes.



Avant de modifier le commutateur de changement de tension ou remplacer le fusible il faut débrancher l'appareil de la prise électrique. Pendant son usage, l'appareil doit être branché à la prise de terre.



Utiliser le fusible principal AC avec la valeur qui est indiquée sur l'étiquette collée sur le coffret.



Assurez-vous que la tension principale AC correspond à celle indiquée dans les spécifications techniques.



L'interrupteur d'alimentation interrompt un pôle du réseau d'alimentation excepté le conducteur de terre de protection. En cas de danger, débrancher le cordon d'alimentation. Parce que la prise du réseau de alimentation est utilisée comme dispositif de déconnexion, ce dispositif doit demeurer aisément accessible.

ISTRUZIONI IMPORTANTI PER LA SICUREZZA

Leggere le presenti istruzioni.

Conservare queste istruzioni.

Osservare tutte le avvertenze.

Seguire scrupolosamente tutte le istruzioni.

Non usare questo apparecchio in prossimità di acqua.

Non ostruire alcuna apertura per il raffreddamento. Installare l'apparecchio seguendo le istruzioni.

Non installare l'apparecchio accanto a fonti di calore quali radiatori, aperture per l'afflusso di aria calda, forni o altri apparecchi (amplificatori inclusi) che generino calore.

Non rimuovere il terminale di connessione a terra sul cordone di alimentazione: esso ha lo scopo di tutelare l'incolumità dell'utilizzatore. Se la spina in dotazione non si adatta alla presa di corrente, rivolgersi ad un elettricista per far eseguire le modifiche necessarie.

Evitare di calpestare il cavo di alimentazione o di comprimerlo, specialmente in corrispondenza della spina e del punto di inserzione sull'apparato.

Utilizzare solo dispositivi di collegamento e gli accessori specificati dal produttore.

Utilizzare l'apparecchio solo con un carrello, un sostegno, una staffa o un tavolo di tipo specificato dal produttore o venduto insieme all'apparecchio. Se si utilizza un carrello, fare attenzione negli spostamenti per evitare infortuni causati da ribaltamenti del carrello stesso.

Scollegare l'apparecchio dalla presa di corrente durante i temporali o quando inutilizzato a lungo.

Per qualsiasi intervento, rivolgersi a personale di assistenza qualificato. È necessario intervenire sull'apparecchio ogniqualvolta si verificano danneggiamenti di qualsiasi natura. Ad esempio, la spina o il cavo di alimentazione sono danneggiati, è entrato liquido nell'apparecchio o sono caduti oggetti su di esso, l'apparecchio è stato esposto alla pioggia o all'umidità, non funziona normalmente o è caduto.

Non esporre a sgocciolamenti o spruzzi. Non appoggiare sull'apparecchio oggetti pieni di liquidi, ad esempio vasi da fiori.

Il prodotto deve essere connesso ad impianti costruiti secondo la regola dell'arte e muniti di protezione differenziale del circuito con valore non superiore agli 0,03A.

Tenere il prodotto lontano da liquidi.

Il prodotto deve essere utilizzato solo se integro e non danneggiato. Se il prodotto è stato sottoposto a forti urti o fosse venuto a contatto con liquidi è necessario contattare l'assistenza prima di accenderlo.

Il prodotto non va aperto per nessun motivo, non va modificato o manomesso. E' vietato tentare qualsiasi tipo di riparazione.

E' obbligatorio leggere il manuale utente prima di utilizzare il prodotto.

Il prodotto deve essere utilizzato da persone adulte. Tenere il prodotto fuori dalla portata dei bambini

Il prodotto va collegato ad impianti costruiti secondo la regola dell'arte e muniti di protezioni magnetotermiche del circuito.

E' proibito sovraccaricare le prese di corrente. E' obbligatorio spegnere il prodotto se non utilizzato.

E' proibito ostruire le aperture di raffreddamento e aerazione.

E' obbligatorio tenere materiali infiammabili/combustibili lontani dal prodotto.

E' vietato utilizzare il prodotto in presenza di sostanze che possano creare atmosfera esplosiva.

Il prodotto va utilizzato posizionato e utilizzato in maniera stabile.



Questo simbolo indica la presenza di alta tensione all'interno dell'apparecchio, che comporta rischi di scossa elettrica.



Questo simbolo indica la presenza di istruzioni importanti per l'uso e la manutenzione nella documentazione in dotazione all'apparecchio.



Non sostituire il fusibile o cambiare la tensione di alimentazione senza aver prima scollegato il cordone di alimentazione. **L'APPARATO DEVE ESSERE CONNESSO A TERRA.**



Sostituire il fusibile generale con uno di identico valore, come indicato sulla etichetta applicata sul mobile dell'apparato



Assicurarsi che la tensione di rete corrisponda a quella per la quale è configurato l'apparecchio.



Questo apparato utilizza un interruttore di alimentazione di tipo unipolare e l'isolamento dalla rete elettrica non è pertanto completo. Per ottenere un isolamento totale (ad esempio in caso di pericolo), scollegare il cordone di alimentazione. Inoltre, poiché la spina di alimentazione è utilizzata come dispositivo di sezionamento, essa deve restare facilmente raggiungibile.

WICHTIGE SICHERHEITSHINWEISE

Diese Hinweise LESEN.

Diese Hinweise AUFHEBEN.

Alle Warnhinweise BEACHTEN.

Alle Anweisungen BEFOLGEN.

Dieses Gerät NICHT in der Nähe von Wasser verwenden.

KEINE Lüftungsöffnungen verdecken. Gemäß den Anweisungen des Herstellers einbauen.

Nicht in der Nähe von Wärmequellen, wie Heizkörpern, Raumheizungen, Herden oder anderen Geräten (einschließlich Verstärkern) installieren, die Wärme erzeugen.

Die Schutzfunktion des Schukosteckers NICHT umgehen. Bei Steckern für die USA gibt es polarisierte Stecker, bei denen ein Leiter breiter als der andere ist; US-Stecker mit Erdung verfügen über einen dritten Schutzleiter. Bei diesen Steckerausführungen dient der breitere Leiter bzw. der Schutzleiter Ihrer Sicherheit. Wenn der mitgelieferte Stecker nicht in die Steckdose passt, einen Elektriker mit dem Austauschen der veralteten Steckdose beauftragen.

VERHINDERN, dass das Netzkabel gequetscht oder darauf getreten wird, insbesondere im Bereich der Stecker, Netzsteckdosen und an der Austrittsstelle vom Gerät.

NUR das vom Hersteller angegebene Zubehör und entsprechende Zusatzgeräte verwenden.

NUR in Verbindung mit einem vom Hersteller angegebenen oder mit dem Gerät verkauften Transportwagen, Stand, Stativ, Träger oder Tisch verwenden. Wenn ein Transportwagen verwendet wird, beim Verschieben der Transportwagen-Geräte- Einheit vorsichtig vorgehen, um Verletzungen durch Umkippen.

Das Netzkabel dieses Geräts während Gewittern oder bei längeren Stillstandszeiten aus der Steckdose ABZIEHEN.

Alle Reparatur- und Wartungsarbeiten von qualifiziertem Kundendienstpersonal DURCHFÜHREN LASSEN. Kundendienst ist erforderlich, wenn das Gerät auf irgendeine Weise beschädigt wurde, z.B. wenn das Netzkabel oder der Netzstecker beschädigt wurden, wenn Flüssigkeiten in das Gerät verschüttet wurden oder Fremdkörper hineinfelen, wenn das Gerät Regen oder Feuchtigkeit ausgesetzt war, nicht normal funktioniert oder fallen gelassen wurde.

Dieses Gerät vor Tropf- und Spritzwasser SCHÜTZEN. KEINE mit Wasser gefüllten Gegenstände wie zum Beispiel Vasen auf das Gerät STELLEN.



Dieses Symbol zeigt an, dass gefährliche Spannungswerte, die ein Stromschlagrisiko darstellen, innerhalb dieses Geräts auftreten.



Dieses Symbol zeigt an, dass das diesem Gerät beiliegende Handbuch wichtige Betriebs- und Wartungsanweisungen enthält.



Vor Änderung der Netzspannung oder Sicherungswechsel Netzkabel trennen.
Das Gerät muss für den Betrieb geerdet werden.



Vor Änderung der Netzspannung oder Sicherungswechsel Netzkabel trennen.
Das Gerät muss für den Betrieb geerdet werden.



Hauptsicherung nur mit einer gleichwertigen austauschen (s. entsprechende Etikette).



Vor Einschalten Netzspannungseinstellung am Gerät überprüfen bzw. anpassen.



Inpoliger Netzschalter. In Notfälle oder für Wartungsarbeiten Netzkabel trennen. Der Netzstecker fungiert auch als Trennelement muss deshalb zugänglich bleiben.

INSTRUCCIONES IMPORTANTES DE SEGURIDAD

LEA estas instrucciones.

CONSERVE estas instrucciones.

PRESTE ATENCION a todas las advertencias.

SIGA todas las instrucciones.

NO utilice este aparato cerca del agua.

NO obstruya ninguna de las aberturas de ventilación. Instálese según lo indicado en las instrucciones del fabricante.

No instale el aparato cerca de fuentes de calor tales como radiadores, registros de calefacción, estufas u otros aparatos (incluyendo amplificadores) que produzcan calor.

NO anule la función de seguridad del enchufe polarizado o con clavija de puesta a tierra. Un enchufe polarizado tiene dos patas, una más ancha que la otra. Un enchufe con puesta a tierra tiene dos patas y una tercera clavija con puesta a tierra. La pata más ancha o la tercera clavija se proporciona para su seguridad. Si el toma corriente no es del tipo apropiado para el enchufe, consulte a un electricista para que sustituya el toma corriente de estilo anticuado.

PROTEJA el cable eléctrico para evitar que personas lo pisen o estrujen, particularmente en sus enchufes, en los toma corrientes y en el punto en el cual sale del aparato.

UTILICE únicamente los accesorios especificados por el fabricante.

UTILICESE únicamente con un carro, pedestal, escuadra o mesa del tipo especificado por el fabricante o vendido con el aparato. Si se usa un carro, el mismo debe moverse con sumo cuidado para evitar que se vuelque con el aparato.

DESENCHUFE el aparato durante las tormentas eléctricas, o si no va a ser utilizado por un lapso prolongado.

TODA reparación debe ser llevada a cabo por técnicos calificados. El aparato requiere reparación si ha sufrido cualquier tipo de daño, incluyendo los daños al cordón o enchufe eléctrico, si se derrama líquido sobre el aparato o si caen objetos en su interior, si ha sido expuesto a la lluvia o la humedad, si no funciona de modo normal, o si se ha caído.

NO exponga este aparato a chorros o salpicaduras de líquidos. **NO** coloque objetos llenos con líquido, tales como floreros, sobre el aparato .



Este símbolo indica que la unidad contiene niveles de voltaje peligrosos que representan un riesgo de choques eléctricos.



Este símbolo indica que la literatura que acompaña a esta unidad contiene instrucciones importantes de funcionamiento y mantenimiento.



Antes de cambiar la alimentación de voltaje o de cambiar el fusible, desconecte el cable de alimentación. Para reducir el riesgo de descargas eléctricas, esta unidad debe ser conectada a tierra.



Remplaze el fusible con lo mismo, que corresponde a lo indicado en el panel del equipo.



Antes de encender, controlar que la línea de alimentación de voltaje corresponda a la indicada.



El interruptor de alimentación es unipolar. En el caso de peligro, desconecte el cable de alimentación. Porque la clavija de conexión a red sirve por la desconexión de la unidad, la clavija debe ser ubicada en proximidad de la unidad.

UNPACKING AND INSPECTION

Your equipment was packed carefully at the factory in a container designed to protect the unit during shipment. Nevertheless, we recommend making a careful inspection of the shipping carton and the contents for any signs of physical damage.

Damage & Claims

If the damage is evident, do not discard the container or packing material. Contact your carrier immediately to file a claim for damages. Customarily, the carrier requires you, the consignee, to make all damage claims. It will be helpful to retain the shipping documents and the waybill number.

Save all packing materials! If You should ever have to ship the unit (e.g. for servicing), it is best to ship it in the original carton with its packing materials because both the carton and packing material have been carefully designed to protect the unit.

Under normal conditions, no user maintenance or calibration is required. Internal links and preset controls may be set to configure the unit during installation. Any service work required should be carried out by qualified service personnel only.

We can offer further product support through our worldwide network of approved dealers and service agents.

To help us provide the most efficient service please would you keep a record of the unit serial number and date and place of purchase to be quoted in any communication regarding this product.

The actual equipment Serial Number is indicated on the silver label stuck on the rear panel of the equipment closure.



Tools and Equipment Needed:

Only standard technician tools are required to install this equipment.

1. FIRST INSTALLATION RECOMMENDATIONS

POWER SUPPLY

The apparatus is equipped with **2** standard **XLR 4-pin** connectors, namely primary and secondary, to facilitate a redundant power supply setup. It is worth noting that the second external power supply is **OPTIONAL**.

The primary external power supply unit and its cable of approx. **1.8 mt.** lengths are supplied with the device, and the type of the power supply cable plug is a **Hybrid CEE 7/7 plug** (compatible with **E** and **F** socket types).

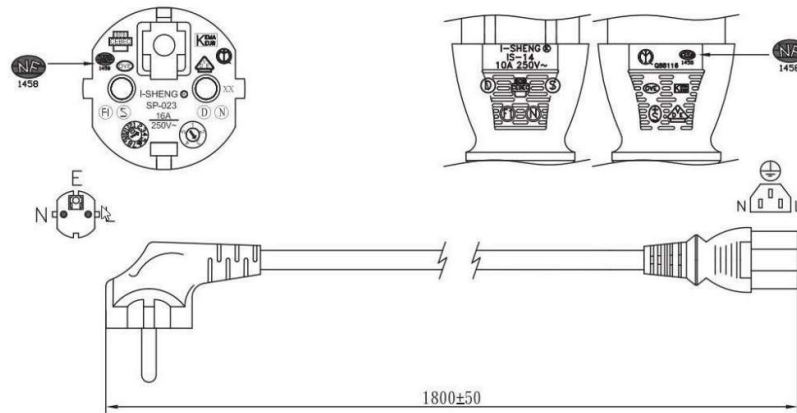

If for any reason, you need to use this appliance with a different plug, you should use the following wiring guidelines in replacing the existing plug with the new one:

| | |
|--------------------|----------------------------|
| Earth | Green, or green and yellow |
| Neutral (N) | Blue |
| Live (L) | Brown |

Supply cables should be laid in such a manner that one does not step or walk on them. They should not be squashed by any objects.

POWER SUPPLY

The device is designed for operation with an external power supply of **100 to 240 VAC**, and **50 Hz to 60 Hz**. Check the corresponding device labeling for compatibility with the domestic line voltage and frequency before connecting the IEC power connector to the main supply!



WARNING

Disconnect the mains power plug before you open the housing. Repair of the equipment must only be carried out by authorized and qualified personnel.

THIS EQUIPMENT MUST BE EARTHED.

The chassis is always connected to the mains earth to ensure your safety and the audio quality: check your mains wiring and earthing before switching it on.



PROTECTION AGAINST LIGHTNING



Should the device be put out of action due to being struck by lightning or excess voltage, disconnect it from the power supply without delay. Do not reconnect until the device has been checked. If in doubt contact the technical support service.

Make sure there is suitable lightning protection to protect the device.

Alternatively, you should disconnect all connectors from the device during a storm or when the device is going to be unsupervised or not used for a longer period.

These measures will protect against damage by lightning or excess voltage.

INSTALLATION NOTE AND FIRST STEP

Best setup location

OXYGEN 3000 PLUS should be installed avoiding direct sunlight, close proximity to radiators and air conditioning, dust, water, and chemicals. Choose a console location that permits a clear view of the indicators on the device and ensures sufficient heat dissipation of the device.

| | |
|------------------------------|---|
| Power Supply | Please make sure that the device and the contained fuse(s) (please see p. 17) are compatible with the domestic line voltage and frequency. If the device is compatible, connect the power supply cord fully to the 4-pin XLR power connector at the rear side of the device and a main power outlet. |
| Network configuration | OXYGEN has a display, so you can configure the IP settings directly: See step. [MORE INFO] |
| Connect to network | Connect a network patch cable to the “10/100-Base-T” connector on the rear side of the device and your existing IP network. |
| Ready! | These first steps are only intended for a quick first start and do not cover all device functions. Please read carefully the entire manual to be able to use all functions of the device. |

FIRST CONNECTION

Connect a LAN cable to the **OXYGEN** LAN port on the back panel of the console. The device is automatically discoverable as a **DHCP** client in your network. Download the **Oxygen Remoter** setup file from the following URL:

[HTTPS://WWW.AXELTECHNOLOGY.COM/PUBLIC/OXYGENREMOTER/OXYGENREMOTERSETUP.EXE](https://www.axeltechnology.com/public/oxygenremoter/oxygenremotersetup.exe)

Launch the downloaded **OxygenRemoterSetup.exe** installation file. Open Oxygen Remoter by clicking on the **OxygenRemoter.exe** icon. You will see the following window: [\[MORE INFO\]](#) 

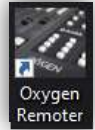

Click on the search device button  on the bottom left.

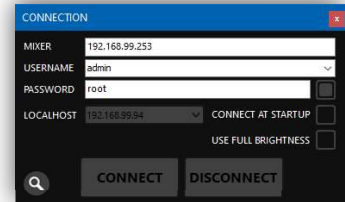

Look for your device in the list and click on it, and click on the **SELECT** button.

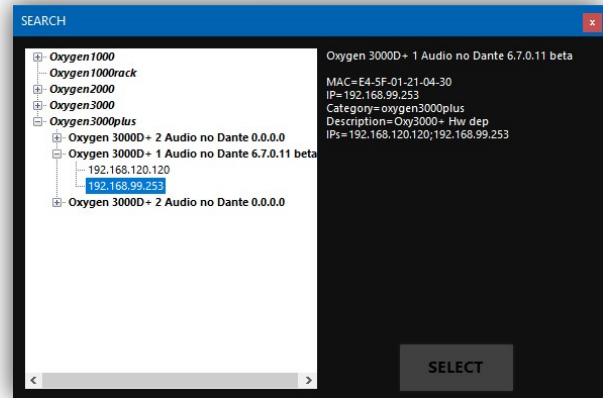

Then click on **CONNECT** button to start **real-time** communication with the target device.

NB:

*Default username: **admin***

*Default password: **root***

The **Localhost** dropdown menu is used to select from which IP address you need to communicate with the console (in case your PC has more than one IP).

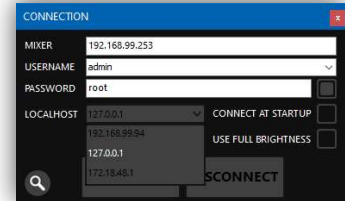

The console is equipped with **two** Internet Protocol (IP) addresses, one of which is assigned as a static IP only (the default IP address is **192.168.120.120**). And the other one comes out pre-set as **DHCP** to facilitate the first connection. Both of them are fully configurable by navigating to **SETUP / GENERAL / COMMUNICATIONS / TCP-IP** [\[MORE INFO\]](#) 

It is possible to **command and monitor** the console using the integrated **display**, **HDMI** out, **Web interface**, and **remoter** software.



INTRODUCTION

OXYGEN 3000 Plus x1 I/O Board



OXYGEN 3000 Plus x2 I/O Board



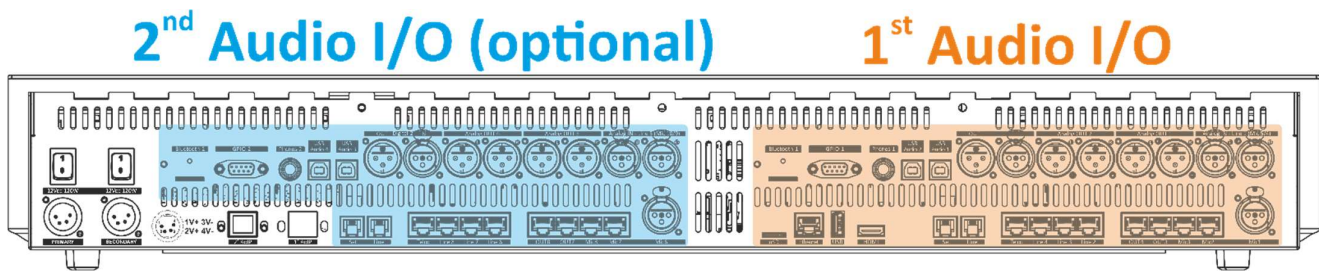

- 8, 12, or 16 faders broadcast digital console
- Analog, digital, USB, AoIP, IP streaming inputs and outputs
- Digital audio routing
- AoIP interface Dante/AES67 (optional)
- Audio Streaming Encoder/Decoder
- User definable Smart Keys for shortcuts and macro commands
- Software for remote control and configuration/settings
- Web interface for configuration/settings
- Backlight RGB buttons
- 16 displays 2" 240x 320 IPS showing channel status, levels, and settings
- 1 display 7" TFT IPS for settings and configuration
- HDMI output
- Latency < 1mSec
- Start-up time <10sec.
- Backup SD Card
- Switching PSU 90/260 Vac 50/60Hz (redundant option available)

2. GENERAL DESCRIPTION

DIMENSIONS (8 PHYSICAL FADERS)

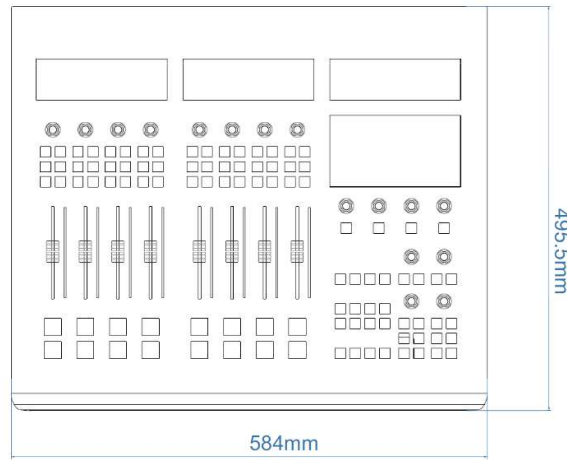

Rear

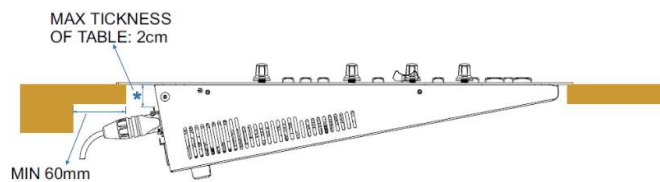
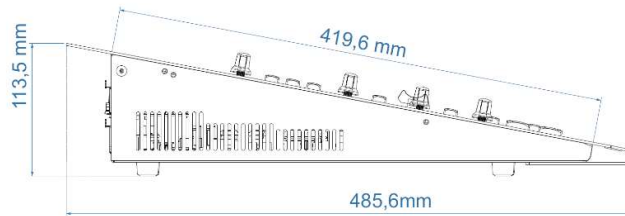
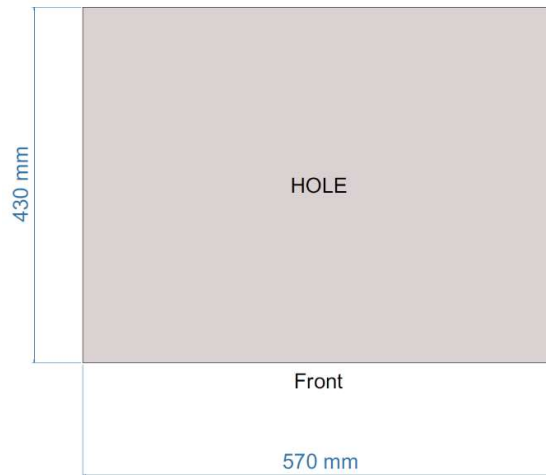

DIMENSIONS (12 PHYSICAL FADERS)

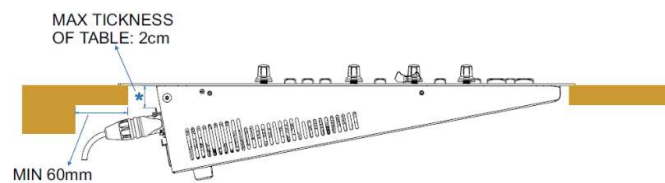
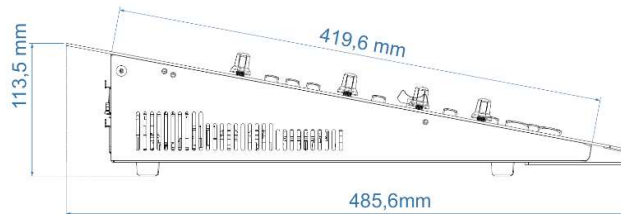
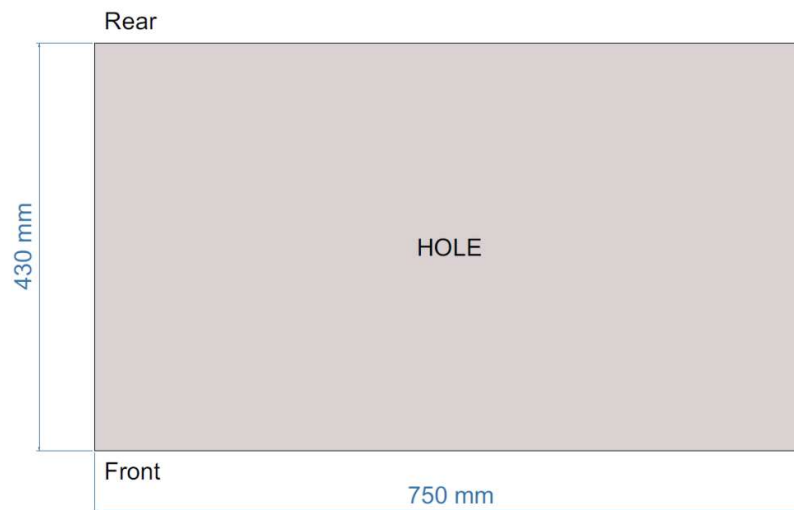
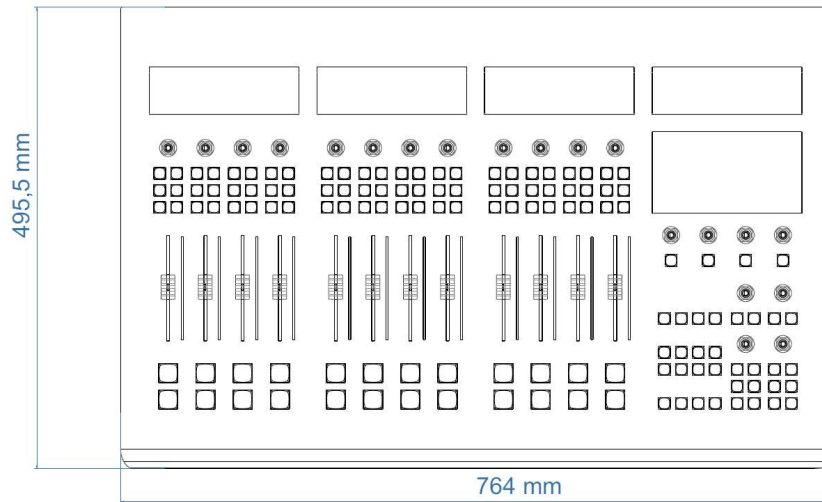

DIMENSIONS (16 PHYSICAL FADERS)

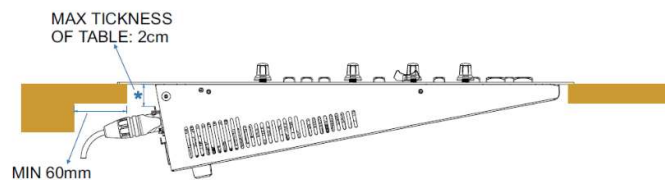
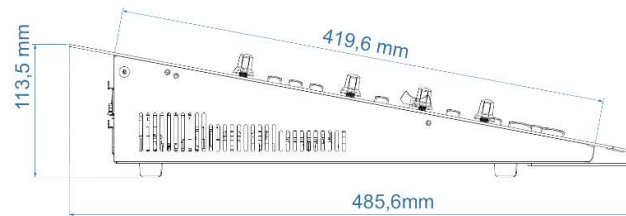
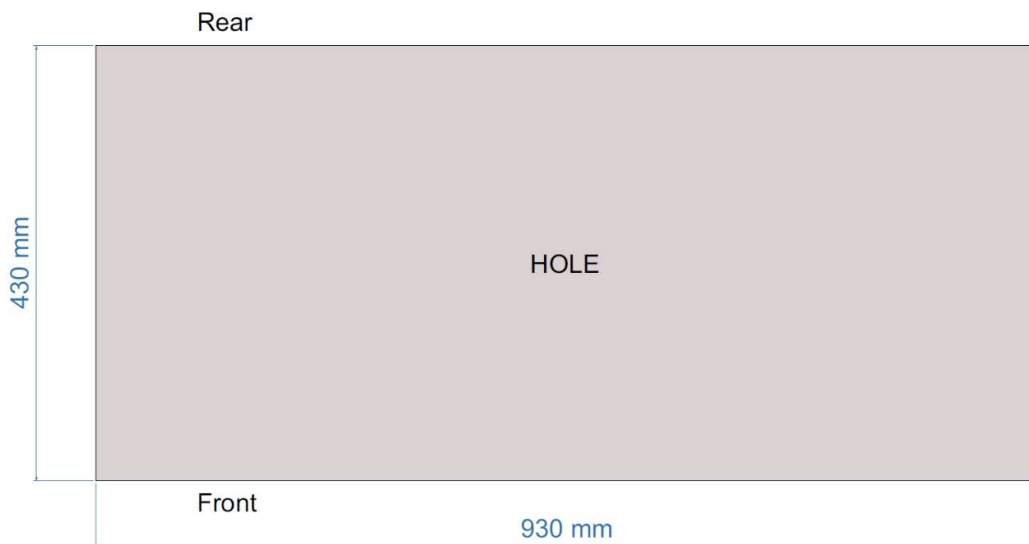
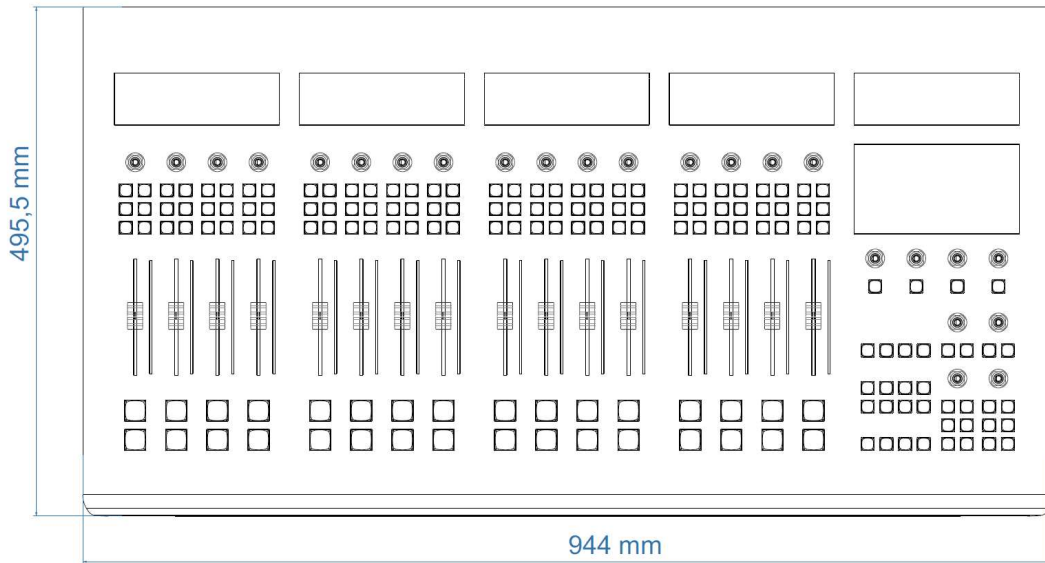

TALKBOX DIMENSIONS

TOP

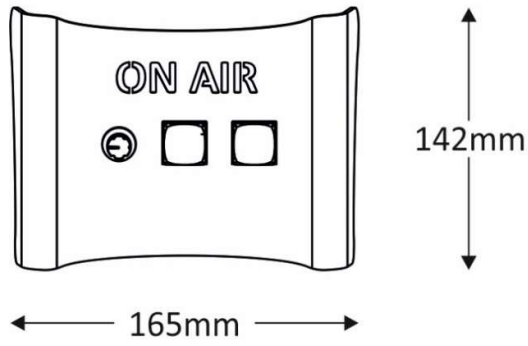

SIDE

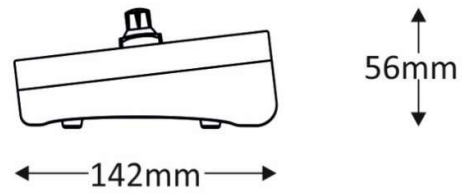

FRONT

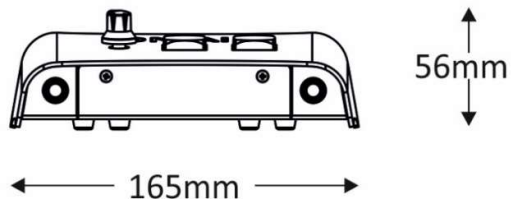

REAR

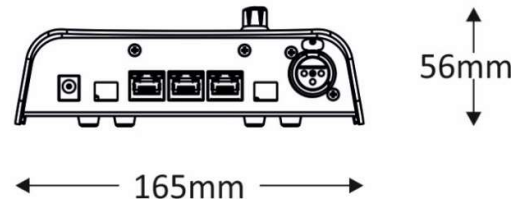

INPUT CONNECTIONS

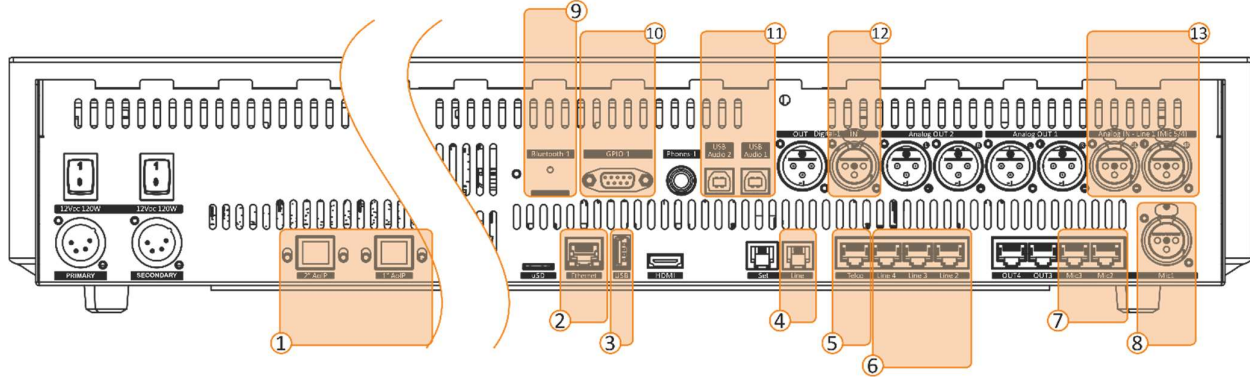

- 1. AOIP – LAN DANTE (OPTIONAL).**
 16 or 32 Stereo digital audio inputs over Ethernet. If the DANTE board was not purchased with the device these inputs are not enabled and do not work.
 Each DANTE channel could be set as:
Stereo, 2 mono, or 2 Telco Inputs. updates.
[MAIN / AUDIO / SETTINGS / INPUT MODE / DANTE / INPUT / MODE](#) [MORE INFO
- 2. Ethernet**
 RJ45 Female Connector Internet Connection used as **streaming audio input**.
 Used also for controlling the console via the Web interface, remote control, and online updates.
[MAIN / GENERAL SET. / COMMUNICATIONS / TCP-IP](#)
 [MORE INFO
- 3. USB**
 A USB port Type A to **Export** and **Import** the mixer configurations and to customize the station LOGO. To configure it navigates to [MAIN / AUDIO / SETTINGS / INPUT MODE](#) [MORE INFO
- 4. Telephone**
 Analog Telephone Line Input (RJ11) for **POTS/PSTN** interfacing. To configure it navigates to [MAIN / AUDIO / INPUTS / PHONE](#) [MORE INFO
- 5. Telco I/O**
 TELCO Input/output over RJ45 connector. It is also carried **2 GPIO** signals for controlling external telephone hybrid or sending status information.
1 GPI to get the incoming call signal by the flashing of the F1 button.
1 GPO to control the external hybrid device for the hook or drop of the calls.
 To configure it navigates to [MAIN / AUDIO / INPUTS / TELCO](#) [MORE INFO
- 6. ANALOG IN (LINE-2, LINE-3, LINE-4)**
 3 Stereo analog audio inputs over RJ45 connectors. Each one of these inputs is configurable to be as:
STEREO by default, **2 MONO**, or **2 TELCO**.
 The user can change the mode of the source by navigating to [MAIN / AUDIO / SETTINGS / INPUT MODE](#) [MORE INFO
- 7. MIC 2, MIC 3**
 MIC input over the RJ45 connector includes **2 GPI** and **1 GPO** on each connector. These 2 ports can be used to connect the **Talk Box** interfacing or connect the mic directly by a special cable called **EASY MIC**. [MORE INFO

Balanced Audio Connection (10 kΩ).
- 8. MIC 1**
 Mic Input - XLR Female - Balanced Audio Connection (1.2kΩ). [MORE INFO
- 9. Bluetooth**
 Bluetooth Stereo/Mono Input.
 Wireless Smartphone **input/output** connection.
 To configure, it navigates to [MAIN / AUDIO / INPUTS / BLUETOOTH](#) [MORE INFO
- 10. GPIO**
 SUB-D 9p Female, **4 GPI** & **4 GPO**.
 To configure it navigates to [MAIN / GENERAL SET. / GPIO](#) [MORE INFO
- 11. USB AUDIO 1, USB AUDIO 2**
2 Audio Card Stereo Input/output **bidirectional** Type **USB-B**.
- 12. DIGITAL INPUT**
 (AESEBU) on XLR Female connector for the digital AESEBU input audio signal. Balanced Audio Connection (110Ω)
- 13. ANALOG INPUT LINE-1 or MIC 4/5**
 1 Stereo Input / 2 Mono / 2 Mic
 Audio LINE level or Mic level Input on XLR Female. Balanced Audio Connection (10KΩ).
 The user can change the mode of the source by navigating to [MAIN / AUDIO / SETTINGS / INPUT MODE](#) [MORE INFO

OUTPUT CONNECTIONS

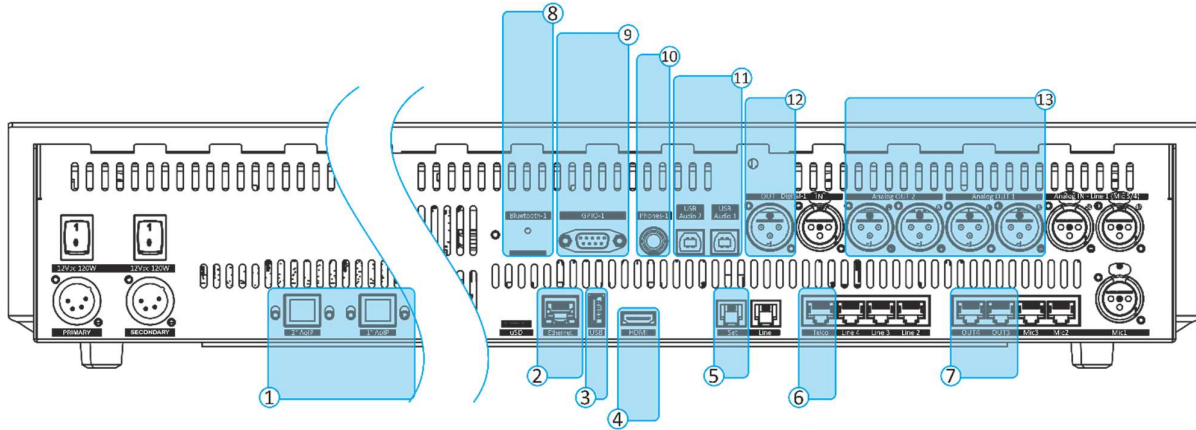

- 1. AOIP – LAN DANTE (OPTIONAL).**
16 or 32 Stereo digital audio outputs over Ethernet. If the DANTE board was not purchased with the device these outputs are not enabled and do not work. Each DANTE channel could be set as: **Stereo, 2 mono, or 2 Telco** outputs. updates.
[MAIN / AUDIO / SETTINGS / INPUT MODE / DANTE / INPUT / MODE](#) [\[MORE INFO\]](#)
- 2. Ethernet**
 RJ45 Female Connector Internet Connection used as **streaming audio output**.
[MAIN / AUDIO / SETTINGS / INPUT MODE / STREAMING](#) [\[MORE INFO\]](#)
- 3. USB**
 A USB port Type A to **Export** and **Import** the mixer configurations. To export the configuration navigate to [MAIN / AUDIO / OUTPUTS / DIGITAL / USB](#) [\[MORE INFO\]](#)
- 4. HDMI Output**
 Standard HDMI Female Connector – External Monitor. To configure it navigates to [MAIN / GENERAL SET. / LIGHT&DISPLAY](#) [\[MORE INFO\]](#)
- 5. Telset** 📞
 (RJ11) used to connect the Telset port to a telephone base unit.
- 6. Telco I/O**
 TELCO Input/output over RJ45 connector. It is also carried **2 GPIO** signals for controlling external telephone hybrid or sending status information.
1 GPI to get the incoming call signal by the flashing of the F1 button.
1 GPO to control the external hybrid device for the hook or drop of the calls.
 To configure it navigates to [MAIN / AUDIO / INPUTS / TELCO](#) [\[MORE INFO\]](#)
- 7. ANALOG OUTPUT (OUT 3, OUT 4)**
 2 Stereo analog audio outputs over RJ45 connectors. Each one of these outputs is configurable to be as: **PGM, SUB, AUX, SPEAKER, HEADPHONE, or TELCO(n-1)**. The user can change the mode of the source by navigating to [MAIN / AUDIO / OUTPUTS / ANALOG](#) [\[MORE INFO\]](#)
- 8. Bluetooth**
 Wireless Smartphone **input/output** connection. Bluetooth Mono phone call communications, Skype, WhatsApp, ...etc.
 To configure, it navigates to [MAIN / AUDIO / INPUTS / BLUETOOTH](#) [\[MORE INFO\]](#)
- 9. GPIO**
 SUB-D 9p Female, **4 GPI & 4 GPO**.
 To configure it navigates to [MAIN / GENERAL SET. / GPIO](#) [\[MORE INFO\]](#)
- 10. HEADPHONES**
 On a female Jack 6,3 mm connector for the audio monitoring with Control Room Headphones.
- 11. USB AUDIO 1, USB AUDIO 2**
2 Audio Card Stereo Input/output **bidirectional** Type USB-B.
- 12. DIGITAL OUTPUT**
 (AESEBU) on XLR Male connector for the digital AESEBU output audio signal. Balanced Audio Connection (110Ω)
- 13. ANALOG-OUT-1, ANALOG-OUT-2**
 2 Stereo Output - XLR Male - Balanced Audio Connection (47Ω) Each one of these outputs is configurable to be as: **PGM, SUB, AUX, SPEAKER, HEADPHONE, or TELCO(n-1)**. The user can change the mode of the source by navigating to [MAIN / AUDIO / OUTPUTS / ANALOG](#) [\[MORE INFO\]](#)

TALKBOX CONNECTIONS

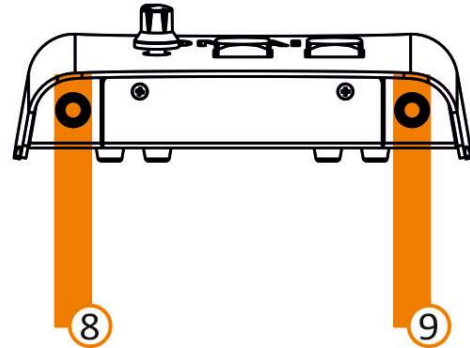
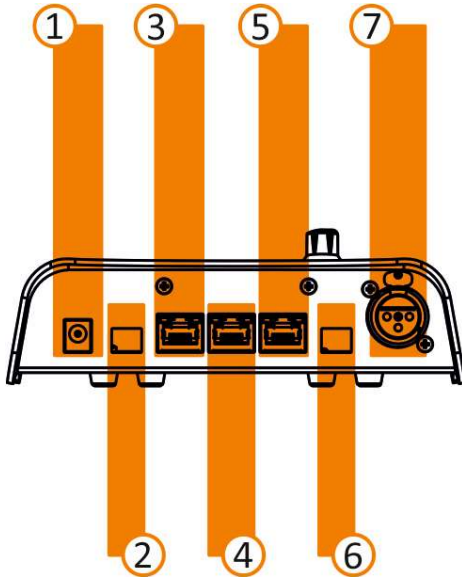

- | | |
|--|--|
| <ul style="list-style-type: none"> 1. Power Supply 12VDC 1A 2. ON AIR Light relay DC relay normally opens NO. 2 PIN Screw Connector. 3. HDP Output RJ45 Connector (SFTP CABLE REQUIRES) - (Passive Loop Output). 4. HDP Input RJ45 Connector (SFTP CABLE REQUIRES) 5. Talk Box Connection MIC & GPIO connection over RJ45 Connector (SFTP CABLE REQUIRES). (Passive microphone Output). | <ul style="list-style-type: none"> 6. Mic Light 2 PIN Screw Connector - (12VDC output). 7. Mic Input XLR Female Connector. 8. HDP-1-TBox Jack 6.3mm Female Connector - (Min. Imp. 32Ω). 9. HDP-2-TBox Jack 6.3mm Female Connector - (Min. Imp. 32Ω). |
|--|--|

3. SURFACE



1. CHANNEL CONTROLS

The console offers **16 physical channel** strips and an additional **8 virtual channels**, affording complete control over the primary parameters of the channel. It features an integrated **LCD screen** for configuring the channel and adjusting the **pre-fader** audio levels. [\[MORE INFO\]](#)

2. SPECIAL FUNCTION BUTTONS

The function keys are used to perform specific tasks. They are labeled as **SNAPSHOTS**, **FUNCTIONS**, and **TALK BACK**. [\[MORE INFO\]](#)

3. MONITORS SECTION

It allows you to manage the **main outputs** (PGM, SUB, AUX, ..etc), monitor signals, and control the loudspeakers and headphones of the **CONTROL ROOM** and the **STUDIO speakers**.

The knob controls the audio level that is monitored using headphones and loudspeakers. Here you can select the sources that will be continuously monitored, and choose individual channels for monitoring by using the **PFL** feature. [\[MORE INFO\]](#)

4. MENU CONTROL BUTTONS & DISPLAY 7" TFT

The **4 knobs** allow you to adjust and confirm the menu parameters. The menu parameters are accessed and controlled through a digital interface that is displayed on the **DISPLAY** or **HDMI out**.

DISPLAY 7" TFT shows different useful elements and information depending on the location in the menu. Used also to navigate through the different menus and lists available in the menu interface. [\[MORE INFO\]](#)

5. OUTPUTS DISPLAY

The LCD display is used to display the status and the stereo audio level of different buses, such as **PGM** (program), **AUX** (auxiliary), and **SUB** (subgroup). Also used to display the status of other monitors, such as **PFL** (Pre-Fader Listen) and other monitoring options. [\[MORE INFO\]](#)

3.1. CHANNEL CONTROLS

CHANNEL DISPLAY

CHANNEL DISPLAY is used to display the status input source and the **PRE-FADER** audio level and the channel configuration. [\[MORE INFO\]](#)

GAIN

knob for the **adjustment** of the input source level and for source **switching** between the primary source (**CH-A**) and the secondary source (**CH-B**) by pressing on the knob. [\[MORE INFO\]](#)

F1 & F2

In the **CALL LINE sources** such as "TELEPHONE, TELCO, OR BLUETOOTH" this button can be set as **TELEPHONE** for the **incoming call signal, hook, and drop** the call.

In other sources like MIC or LINE, it can be configured to **activate** or **deactivate** some functions such as compressor, ducking, and EQ. [\[MORE INFO\]](#)

PGM

Button to send the channel to **PGM BUS**. [\[MORE INFO\]](#)

SUB

Button to send the channel to **SUB BUS**. [\[MORE INFO\]](#)

AUX1

Button to send the channel to **AUX-1 BUS**. [\[MORE INFO\]](#)

AUX2

Button to send the channel to **AUX-2 BUS**. [\[MORE INFO\]](#)

FADER

The fader allows the source level attenuation. [\[MORE INFO\]](#)

FADER LED BAR

It indicates the attenuation level and the source type by setting different colors for each type of audio source. [\[MORE INFO\]](#)

ON/START

Button to switch between **STANDBY** and **ON AIR** for the selected source. [\[MORE INFO\]](#)

PFL

This button allows you to hear the **Pre-Fader Listening** to control the audio quality and level before sending it to ON AIR. It is also used to talk privately (off-air) with the phone caller. [\[MORE INFO\]](#)

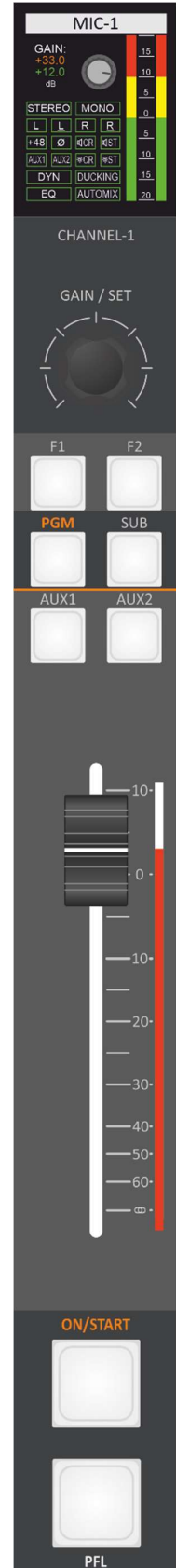

3.1.1. CHANNEL DISPLAY

provides visual feedback on the status of the input source and the **PRE-FADER** audio level and the channel configuration. It is contained much useful information about the source configuration such as PRE-AMP, Gain, Pre-Fader Listen, signal type, Phantom, speaker cutting , on-air light, and much more.

If you need to see more information (PRE, POST, EQ spectrum), control and change the configuration of this source, navigate to the source page on the MENU.

For example [MAIN / AUDIO / CHANNELS / CHANNEL 1 / A-CONFIG](#) [\[MORE INFO\]](#)

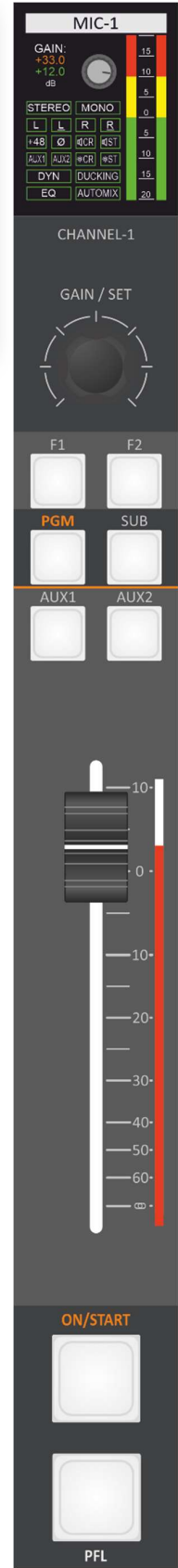

3.1.2. GAIN

In addition to adjusting the input level, the knob can also be used to switch between different audio input sources. This is typically done by pressing down on the knob, which will toggle between the primary source (**CH-A**) and the secondary source (**CH-B**). This feature is useful when you want to switch between different audio sources quickly without having to go through a menu or button controls.

- The rotation of the GAIN knob corresponds to an increase or decrease in the gain of the selected input source.
- The GAIN value is linked with the chosen source, **ChA/ChB**, as opposed to the physical channel.
- Upon switching the source, the GAIN automatically adjusts to the connected source, rendering it suitable for use.
- When the GAIN knob is rotated, a **small window** is opened in the main menu display, depicting the GAIN level.
- The GAIN value is the most recent setting selected by the knob, and it impacts the input level within a range between **-20 dB to +20 dB**.
- The GAIN adjustment knob can be set in steps of **0.1 dB**.

It is also can change the GAIN level from the menu by navigating to [MAIN / AUDIO / CHANNELS / CHANNEL 1 / A-CONFIG](#) [\[MORE INFO\]](#)



3.1.3. F1 & F2

These are 2 configurable buttons that can be set in the physical channel to **enable/disable** many features such as (TalkBack, COMPRESSOR, DUCKING, and EQ).

- In the **CALL LINE sources** such as "TELEPHONE, TELCO, OR BLUETOOTH" this button can be set as **TELEPHONE** for the **incoming call signal, hook, and drop** the call.
- In other sources like **MIC or LINE**, it can be configured to **enable/disable** some functions such as compressor, ducking, and EQ.

The console features a button for signaling incoming calls and answering or ending calls on the associated phone line, be it **TELEPHONE, TELCO, or BLUETOOTH**. When an incoming call is detected, the F1 button begins to flash, indicating its presence. By pressing the F1 button, the call is answered and subsequently hooked.

- F1 LED **off** = the line is **not hooked**.
- F1 LED **blinks** = there is an incoming call (**RING**).
- F1 LED **on** = the line is **hooked**.

By pressing **F1** again you drop the line.



For other sources, such as MIC or LINE, the **F** button can be configured to **enable or disable** certain functions, such as compressor, ducking, and EQ.

To change the F1 button mode of mic 1 for example, navigate to

[MAIN / AUDIO / INPUTS / MIC / MIC 1 / ADV. SETTINGS \(page 2/3\)](#) [\[MORE INFO\]](#)

3.1.4. PGM, SUB, AUX1, AUX2

The **PGM, SUB, AUX-1,** and **AUX-2** buttons **enable/disable** the output signal routing on the related **BUS**, the RGB LEDs under the related button has three different states color:

- 1) disabled (LED OFF)
- 2) enabled + Channel ON
- 3) enabled + Channel MUTE

The Different in **PGM,** and **SUB** BUS's status, it's not associated with the source, like AUX-1, AUX-2, EQ, and GAIN but with the physical channel. when you change the source, the BUS's status will not change.

It's possible to set **AUX-1** and **AUX-2** to be **POST-Fader, PRE-Fader, or PRE-FADER ALWAYS ON**. This choice is settable in the settings menu of every channel's input source. To configure the AUX BUS of the first microphone, for example, navigate to

[MAIN / AUDIO / INPUTS / MIC / MIC 1 / ADV. SETTINGS \(page 2/3\)](#) [\[MORE INFO\]](#)

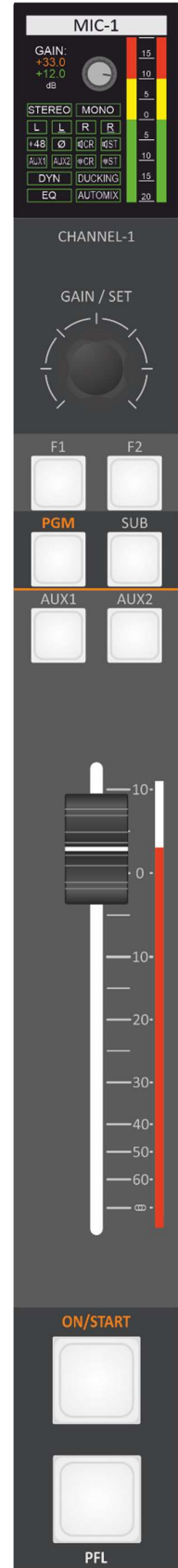

When a channel switches from **ON** to **OFF** or standby status, the related LEDs switch from ON Colour to standby color. this function allows us to understand the channel and BUS's status.

ON/OFF channel status could depend on:

- ON/START button.
- Fader position.

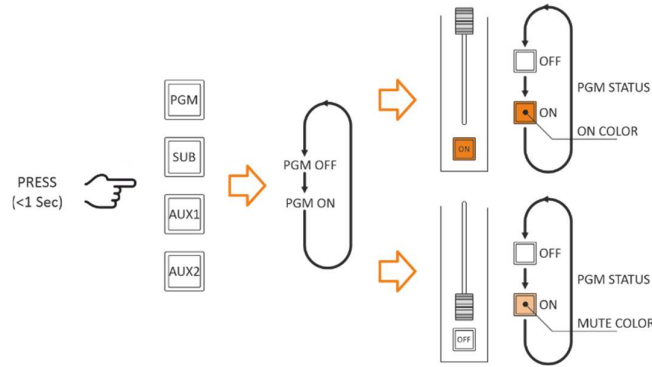

3.1.5. FADER

A command is generated every time the Fader passes through the threshold value:

ON - crossing the threshold point from bottom to top.

OFF - crossing the threshold point from top to bottom.

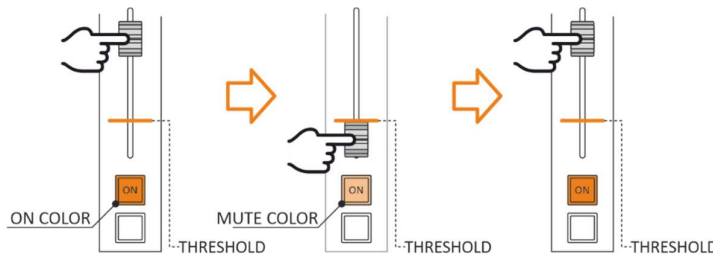

Differently, from the EQ and the GAIN, the FADER status is not associated with the source, it is associated with the physical channel. Changing the source, the FADER attenuation and the FADER position will not change.

ATTENTION:

It is possible to set AUX-1 and AUX-2 to be POST-Fader or PRE-Fader.

The FADER does not affect the signal in the **PRE-FADER** case.

3.1.6. FADER LED BAR

The **FADER** LEDs BAR shows the channel level. It indicates the attenuation level and the source type by setting different colors for each type of audio source.

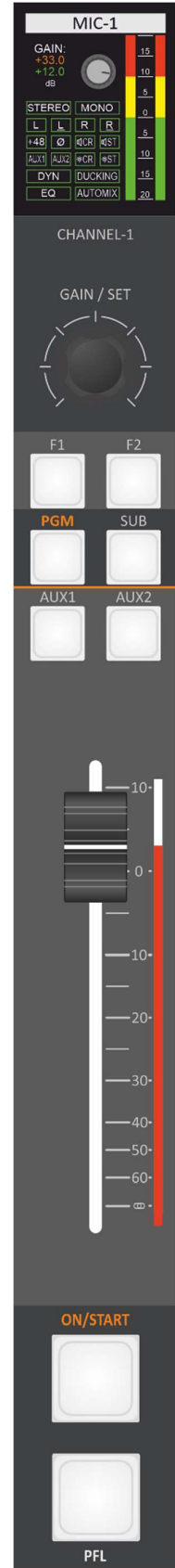
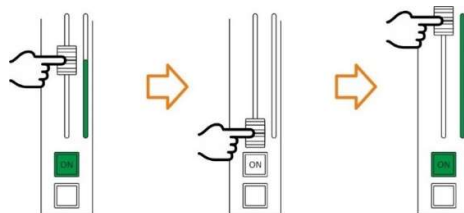

3.1.7. ON/START

This button to **enable/disable** the channel (ON/OFF), the OFF status mutes the channel automatically, and the RGB LEDs under the buttons have three different statuses:

- 1) **LED OFF** - OFF status - the channel is MUTE.
- 2) **LED ON** in (warm color) - ON status – the channel is OPEN.
- 3) **LED ON** in (light color) – standby status.

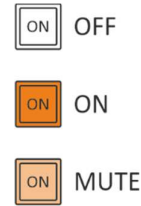

Differently, from the **EQ** and the **GAIN**, the **ON/OFF** status is not associated with the source, it's associated with the physical channel.

The **ON/OFF** channel status could be changed by: pressing at **ON/START** button as shown below.

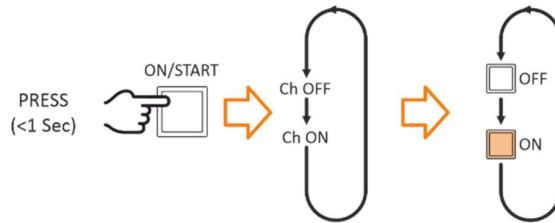

3.1.8. PFL

This button **enables/disables** the **Pre-Fader Listen** of the channel. When the button's LED is ON, the PFL is enabled on that channel.

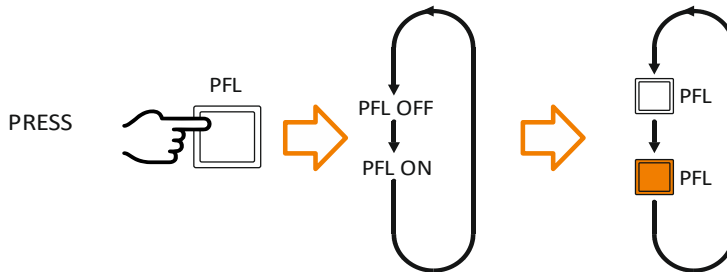

PFL, its effect appears on any of the monitors (headphones and loudspeakers) if that monitor mode is **+PFL**. like (**SEL+PFL**, **1SEL+PFL** or **2SEL+PFL**).

For example:

To activate **PFL** in Control Room speakers (**SPK-CRM**), follow up this path to change the mode to **+PFL**.

MENU / AUDIO / OUTPUTS / MONITOR / SPK-CRM / MODE
(1SEL+PFL, 2SEL+PFL) [\[MORE INFO\]](#)

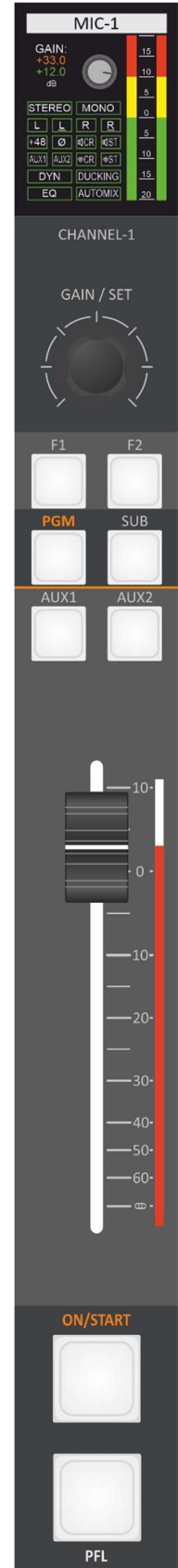

Going to **MENU / AUDIO / OUTPUTS / MONITOR / SETTINGS** can change the **PFL MODE** between **SINGLE PFL** and **SUM PFL** and with the SUM PFL you can listen to more than one PFL at the same time. [\[MORE INFO\]](#)

SINGLE PFL: Allowed to select/listen to only one PFL per time.

SUM PFL: Allowed to select many PFLs and listen to them all at the same time.

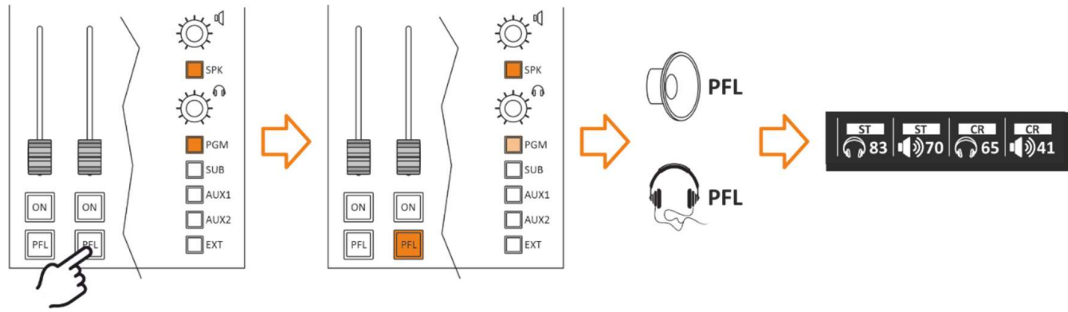

Differently, from the **EQ** and **GAIN** the **PFL** status is not associated with the source, it's associated with the physical channel. Changing the source, the **PFL** status will not change.

PRIVATE MIC

if you press the **PFL** (Pre-Fader Listen) button on the telephone channel, any microphone that is set as a private microphone will be able to communicate with the caller in private, ***even if the fader is closed***. This can be useful in situations where you need to have a private conversation with the caller without it being heard ON-AIR audio feed.

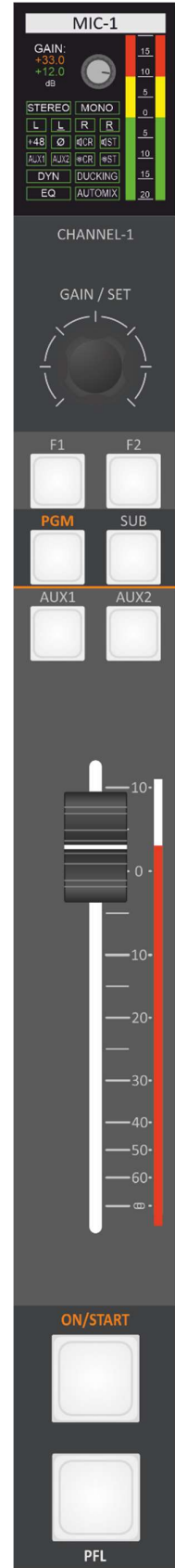

3.2. SPECIAL FUNCTION BUTTONS

3.2.1. SNAPSHOTS

Here we have **4 buttons** and each button can be set to recall a specific CHANNELS snapshot that you've saved.

Snapshot functionality allows you to save **10 presets** for CHANNELS and can select which parameter to recall from the snapshot (EQ, COMPRESSOR, BUS ASSIGNMENT, FADER, PRE-MIC LEVEL, CHANNEL ON/OFF) and much more.

To configure the CHANNELS snapshots from the surface and display, navigate to

MAIN / SNAPSHOT / ADV.SETTINGS

By this section, you can easily save and load up to **10 presets**.

Into each preset (1, 2, 3, 4, 5, 6, 7, 8, 9, 10) you can store all the current Channels (CH1, CH2, CH3...CH10) status related to **Audio Inputs (CHA and CHB) assignment, EQ and COMPRESSOR**.

It is possible to give a name for each snapshot. When you save a snapshot, you give it a name so that you can easily recall it later. This is where the buttons you mentioned come in.

For example, let's say you have four different configurations of your mixer that you commonly use: one for a live performance, one for recording vocals, and one for podcasting. You can save each of these configurations as a snapshot and assign each snapshot to a button on the mixer.

Then, when you need to switch between these configurations, you can simply press the corresponding button, and the mixer will recall the snapshot associated with that button, instantly applying all of the settings you've saved for that particular scenario. This can be a huge time-saver and makes it easy to switch between different tasks or setups on the fly.

3.2.2. FUNCTIONS

Smart Keys are 8 useful buttons available on **OXYGEN**.

Their standard names are **K1, K2, K3, K4, K5, K6, K7, and K8**.

They can be used to make the same console itself send IP Commands in **TCP** or **UDP** or **REST API** protocol to an external system as:

- an external software
- an external device

The Oxygen allows you to set and manage 2 different kinds of outgoing **IP commands**:

- The first one works with **SMART KEYS** and could be managed by Oxygen Smart Keys.
- the second one works with **TRIGGER** and could be managed by the desired Oxygen channel slider and related "ON/OFF buttons" = ON [\[MORE INFO\]](#)

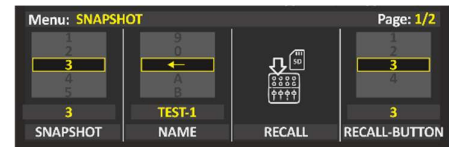
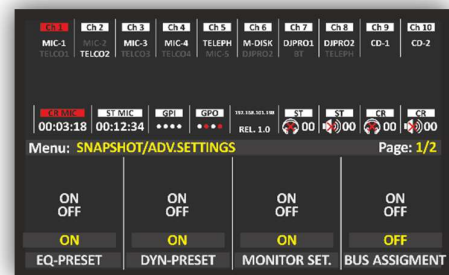

3.2.3. TALKBACK

The talkback system is a system used to facilitate communication between the mixing engineer or producer and the performers or other personnel in the studio.

The mixing engineer or producer can use the talkback button on the mixing console to activate the microphone and communicate with other personnel in the studio, such as an assistant engineer or a technician, to coordinate technical tasks and troubleshoot issues.

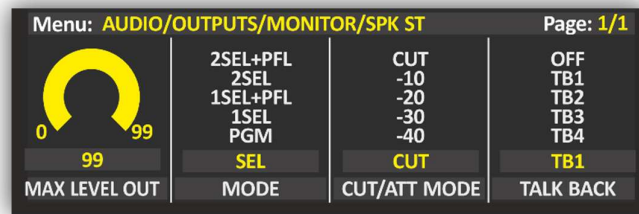

MENU / AUDIO / OUTPUTS / MONITOR / SPK-STUDIO / TALKBACK
(TB1, TB2, TB1+TB2) [\[MORE INFO\]](#)

Here you can **disable/enable** the **TALKBACK** communications.



3.3. MONITORS SECTION

LOUDSPEAKERS & HEADPHONES

- This section is used for the management of the **Control Room** and **Studio** loudspeakers and Headphones.
- The rotary control knobs allow you to **amplify/attenuate** the audio level.
- The audio level goes from **0** to **99** is the maximum allowed level. Can set the maximum level by going to this page:
MENU / AUDIO / OUTPUTS / MONITOR / SPK-CRM
- The step of the loudspeaker adjustment is **1 dB** and the level goes from **-80 dB** to the maximum of **+19 dB**.
- By **pressing the knob**, you can mute  or play the control room monitors if it is already muted.
- To unmute the speaker  just press the knob or **increase/decrease** the audio level by rotating the knob and confirm that by clicking on the same knob.
- The loudspeaker's level and status are displayed in the bottom-right section of the LCD.



MODE: 1SEL, 1SEL+PFL, 2SEL or 2SEL+PFL

PFL (pre-fader listen): This mode allows you to listen in speakers to the audio of the single channel **before** the intervention of the fader.

1SEL (one selection): This option allows you to listen in speakers to only ONE selected output from the output section ④ (PGM, SUB, AUX1, AUX2, EXT).

1SEL+PFL: This mode allows you to listen to **ONE selected output** or **PFL** if press the button PFL of one channel.

2SEL (two selections): This option allows you to listen to ONE selected output ④ (PGM, SUB, AUX1, AUX2, EXT), And by pressing the **SPK** button ② you will be able to listen to different outputs in speakers.

EX.: if you need to listen to different output in **SPK-CRM** Control Room Speakers, select the **2SEL** mode from the setting and press the **SPK** button in section ② (it will show up in warm color), then press any other output button from section ④ (it will show up in warm color) to hear that output in the speakers only. (see the next figure).

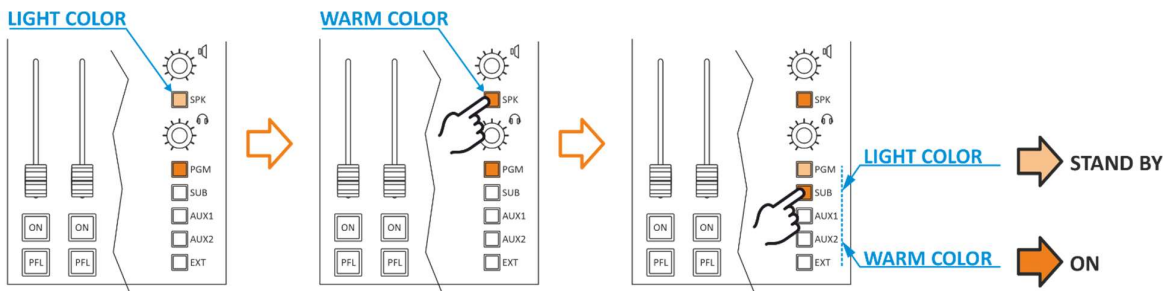
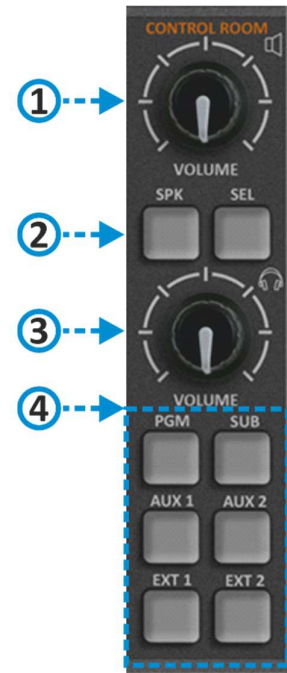

2SEL+PFL: It is a similar mode to the above-mentioned case, in addition to that you can hear the **PFL** in a bout of headphones and speakers simultaneously. (see the next figure).

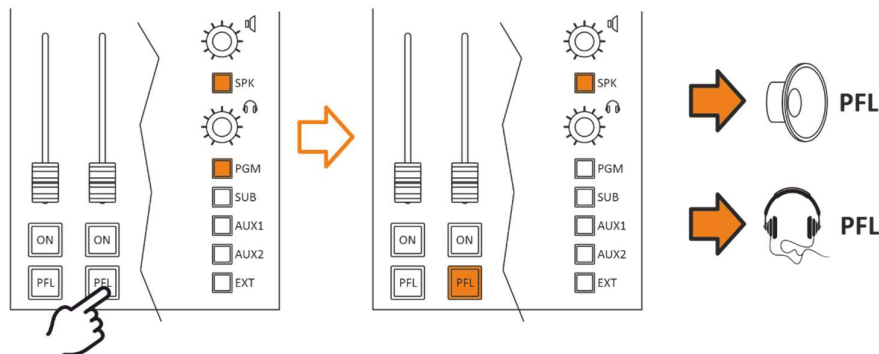

CUT-ATT-MODE

MENU / AUDIO / OUTPUTS / MONITOR / SPK-CRM / CUT-ATT-MODE

CUT MODE: it's allowed the microphone to **CUT OFF** the audio of control room loudspeakers once the microphone goes to ON. The opening of a microphone channel (if configured appropriately) can generate

the closing command of the loudspeakers. That is possible to choose one or more microphones to cut the loudspeaker output of the **CR** “Control Room” by following this path:

MENU / AUDIO / INPUTS / MIC / SPK-CUT
(OFF, ST, CR, CR+ST)

When you select **CR**, press down the knob to confirm the selection and the **CR** will show up in yellow color.

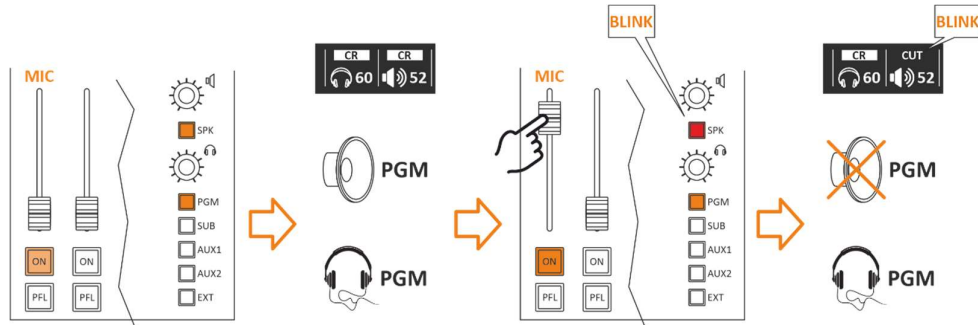

When you open the associated source with a **CUT** function you will see it will **MUTE** CR Loudspeakers output to prevent **LOOP** audio and the SPEAKER icon at LCD will start plinking.

ATT. (attenuation) MODE: It helps reduce acoustic flux from flowing into the speakers.

Is it possible to decrease the output of the loudspeaker to **-40, -30, -20, or -10 dB**.

EX.: If we want to reduce the sound coming out of the speakers by **40 dB** less than the current value, then we have to choose **-40**. The same thing if we want to reduce the current volume when opening any of the microphones with a value of **10** decibels, then we have to choose **-10** and confirm the selection by pressing the button around until the selection color changes to yellow.

The **CUT** mode is triggered by the change from **OFF** to **ON** of a microphone source to which it has been set closing of the loudspeaker.

As shown in the MENU this function (**CUT**) is associated only with the loudspeakers, to avoid LARSEN effects “feedback loop” from occurring between the nearby loudspeakers and On-Air microphones.

On the other hand, if you need to **MUTE** the loudspeakers manually just **PRESS** the volume knob down. **PRESS** the volume knob a second time or rotate it to activate the loudspeaker output and amplification or attenuation. The status of **MUTE-SPK** is indicated by a red cross on the SPEAKER icon.

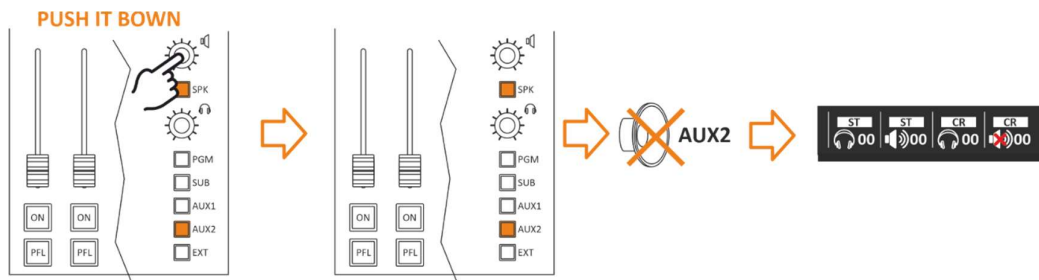

TALKBACK

Here is where can **disable/enable** the **TALKBACK** communications in the loudspeaker’s output. Normally the talkback is used to communicate between the mixer man and the people in the studio via headphones. This option gives you the possibility to hear the people talking in TALKBACK the studio via the **CR** (Control Room loudspeakers).

MENU / AUDIO / OUTPUTS / MONITOR / SPK-CRM / TALKBACK
(OFF, ON)

3.4. MENU CONTROL

BUTTONS & DISPLAY 7" TFT

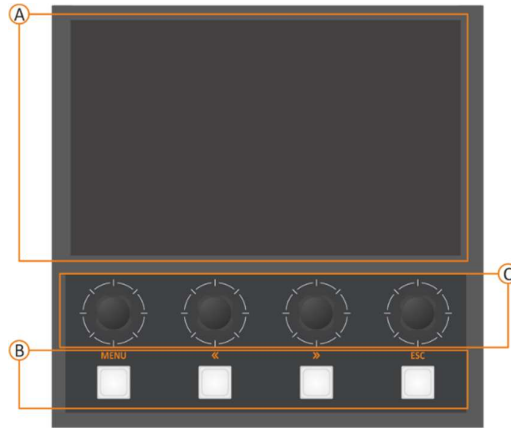

A. COLOR DISPLAY 7" - 800X480 RESOLUTION

The display is used to control the mixer setting and monitor all the parameters and it has its own configuration menu. The display has some parameters that can be changed like **DIMMER** and **LOGO**. It is possible to adjust the display brightness, allowing you to deal with any environmental situation. You can find the parameter in the following menu: **GENERAL SETTINGS/LIGHT & DISPLAY/DISPLAY/DIMMER (low, mid, high)**. It is possible to have the logo of your own station on the Mixer display. The image must be **330x280px** in **PNG** format.

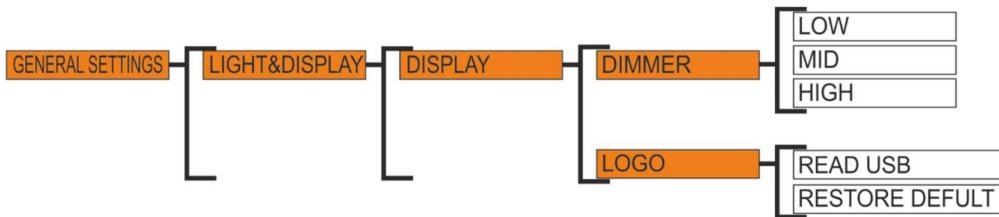

The **HOME THEME** parameter defines what to see on the display in standard conditions when no function has been recalled.

The following picture is the **HOME PAGE**:

1. **OFF / STAND-BY / ON-AIR** channel STATUS.
2. Source names associated with channels.
3. Logo display.
4. NTP synchronized clock & Mic timer.
5. ONAIR mic status.
6. GPIO 1&2 status.
7. Speakers and Headphones status.
8. Firmware release and IP address.

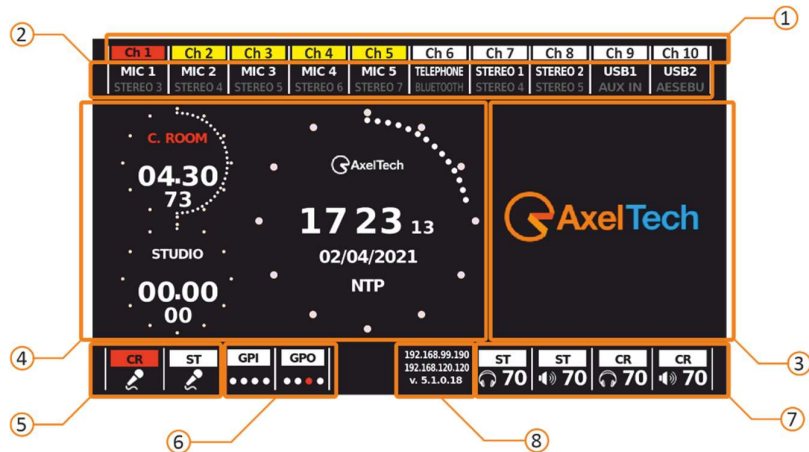

B. BUTTONS FOR THE MENU NAVIGATION

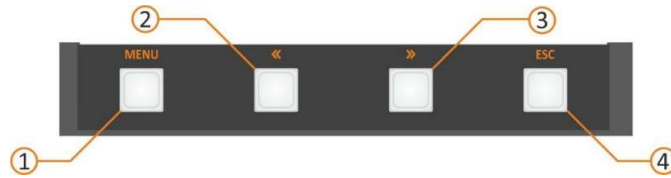

- 1) The **MENU** button switches from HOME to MENU. With this button, you can recall the mixer configuration menu.

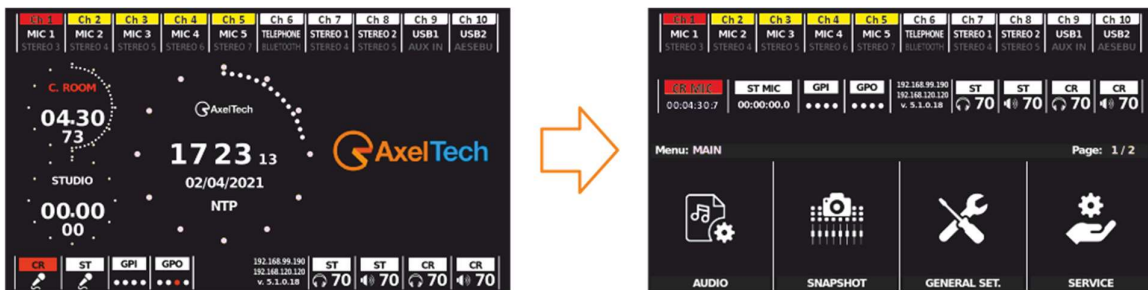

Buttons **2** and **3** (>> and <<) allow you to move between pages of **parameters/functions** on the same menu level. **ESC (button 4)** allows you to exit from the menu level going in the menu.

C. ENCODER FOR THE MENU NAVIGATION

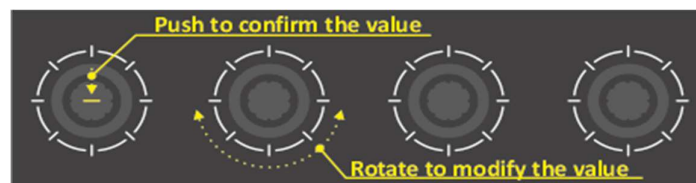

- The 4 knobs allow you to adjust and confirm the menu parameters.
- It is also possible to **PUSH** the knob to confirm the parameter setting.
- Menus are designed to have a perfect match between graphics and knobs.
- Parameter changes will be directly applied to the audio of the aired channel.
- The yellow value represents the stored value.
- While a knob is being moved the circle becomes white. A white value appears in the middle of the circle. The new value represents an instantaneous value that is different from the stored one.
- Push the related knob to confirm the parameter changes. Once you have confirmed the new value, the graphic will become yellow again.
- At the **ESC** press or at the next screen change if the changes will not be confirmed, the value will be restored to the one previously saved.

D. MENU display parts

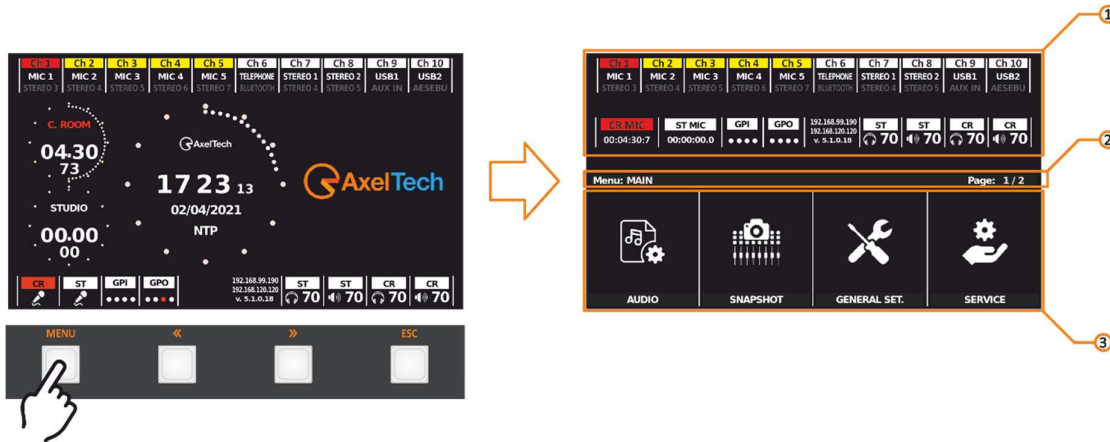

1. In this part of the display can see some useful elements and information depending on the location of the MENU.
2. From here you can browse all lists available in the menu.
3. To navigate the root of your page. The page number indicates the pages available and the current page.

3.5. OUTPUTS DISPLAY

A built-in LCD audio level bar graph meter.



The LCD audio level bar graph meter would display the audio level for each of the mixer outputs, including PGM, SUB, AUX1, AUX2, and PFL. This would allow the operator to easily monitor the level of each output and make adjustments as needed to ensure that the audio is properly balanced and not distorted.

It also contains the status of **audio monitoring** devices, such as loudspeakers and headphones. This would allow the operator to control the volume of the monitors and audio routing.

In addition, on the far right side are displayed some details about the date, time, and **2 TIMERS**. This information could be useful for keeping track of recording sessions or live events and ensuring that everything is running on schedule.

4. MENU

4.1. AUDIO

4.1.1. SETTINGS

INPUT MODE

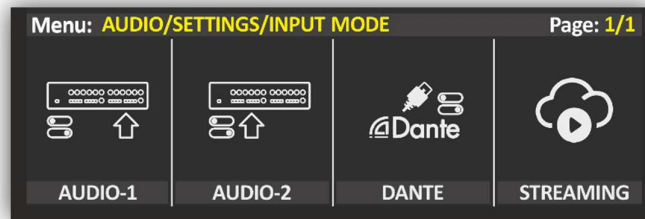

This menu allows you to configure the inputs or sources of the mixer to work in different modes, such as stereo or two mono channels.

In stereo mode, the input signal is split into two channels, typically a left and right channel, allowing for stereo panning and spatialization effects in the mix. In **2 MONO** mode, the input signal is treated as two separate mono channels, which can be independently processed and mixed into the final output.

In the case of **2 MIC** mode, the mixer would allow two separate microphone inputs to be used independently.

Additionally, you mentioned that with Dante sources, there is an option to configure the inputs as "2TELCO".

STREAMING

To configure the streaming sources **ENCODER** and **DECODER**, [please check the WEB interface user manual](#). For example, to configure the streaming input (DECODER), go to the OXYGEN web interface and navigate to **MAIN / AUDIO / INPUTS / DIGITAL / STREAMER 1 / STREAMING SETTINGS**

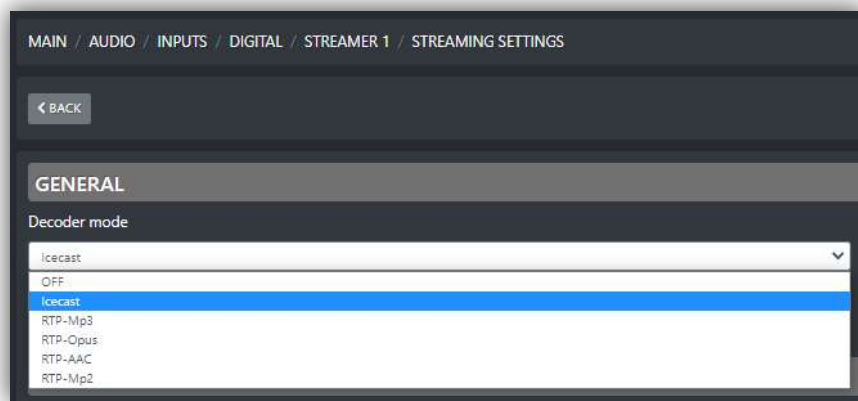

SURFACE MODE

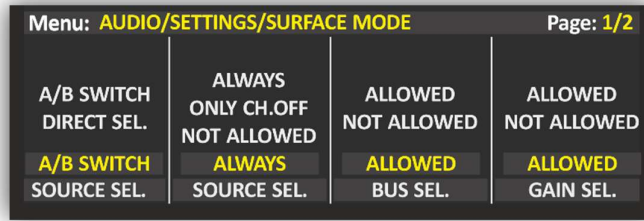

SOURCE SEL

ALWAYS ALLOWED: you can always switch between **A/B** channel sources whenever it's pressed the **GAIN** knob.

FADER SETTINGS

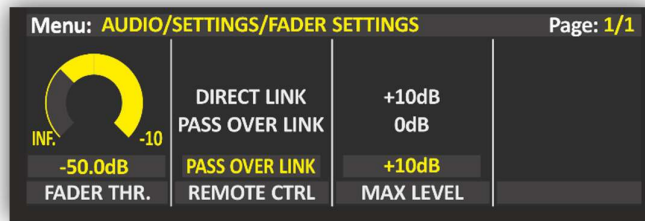

FADER THRESHOLD

The setting of this threshold parameter allows you to establish the minimum threshold of each fader, so that above it the channel is **ON**, and below it, the channel is **OFF**.

In this previous example every time the channel fader goes above **-50 dB** the channel will be activated. Every time the channel fader goes below **-50** the channel will be deactivated.

FADER REMOTE CONTROL MODE

This parameter allows you to manage the relationship of all channels between the relative physical slider and the corresponding virtual slider:

DIRECT LINK: this setting always maintains the coordination between the movement of the physical slider and the movement of the related virtual slider within the **OXYGEN REMOTER**. The physical slider always drags the virtual slider with itself.

PASS OVER LINK: this setting takes effect every time the virtual slider is **raised/lowered** by OXYGEN REMOTER. The related physical slider is disconnected and even if moved it does not drag the virtual slider of OXYGEN REMOTER with itself.

In order for the physical slider to have control over the virtual slider again, you should put the physical slider level into the following condition:

$$\text{Physical Slider Level} = \text{Virtual Slider Level}$$

VJ PRO MODE

If you have the Axel Technology **VJPRO** Console software this will be the console Channel controllers of VJPRO.

| Menu: AUDIO/SETTINGS/INPUT MODE/DANTE BOARD Page: 1/2 | | | |
|---|--------------|--------------|--------------|
| EMPTY | EMPTY | EMPTY | EMPTY |
| MIC-1 | MIC-1 | MIC-1 | PGM |
| MIC-2 | MIC-2 | MIC-2 | SUB |
| MIC-3 | MIC-3 | MIC-3 | AUX-1 |
| MIC-4 | MIC-4 | MIC-4 | AUX-2 |
| EMPTY | EMPTY | EMPTY | EMPTY |
| CTRL SOURCE | SOURCE-1 | SOURCE-2 | BUS SOURCES |

CTRL-SOURCE: The **DJPro** (Radio side) audio source is rooted automatically in the PGM. We suggest you select USB AUDIO-1.

SOURCE-1: First **VjPro** Console (TV side) audio source, in this channel you have a clip related to the **DjPro** song. The Audio rooting is specified by the last **BUS-SOURCE** parameter. We suggest you select LINE-4.

SOURCE-2: Second **VjPro** Console (TV side) audio source, in this channel you have a preloaded clip of the LINE-4 next clip. Useful source if the radio song length is shorter than the TV clip length. The Audio rooting is specified by the last **BUS-SOURCE** parameter. We suggest you select LINE-5.

BUS-SOURCE: General TV audio BUS for **SOURCE-1**(LINE-4) and for **SOURCE-2**(LINE-5). We suggest you select AUX-1.

4.1.2. INPUTS

You can set Input source parameters from the menu **MENU / AUDIO / INPUTS** by PUSH/RUTATE the knobs as in the following steps.

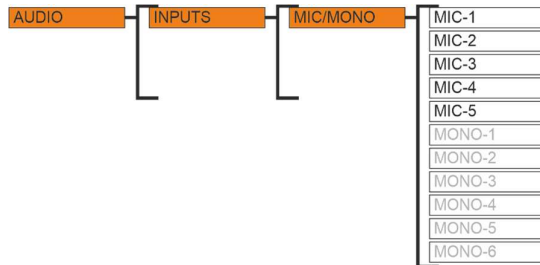
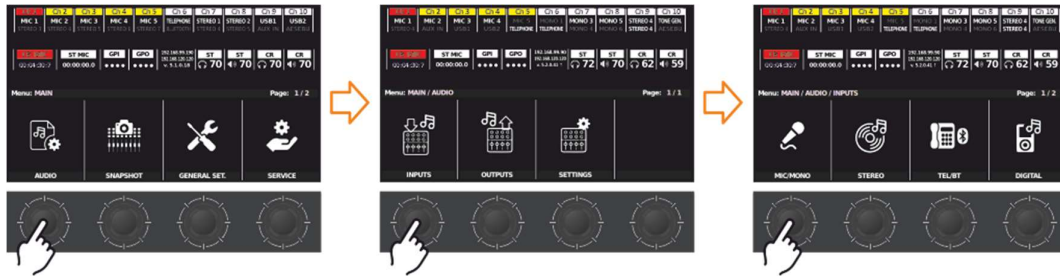

From this level of the menu, you choose which input source you like to customize.

MIC (MIC-1 to MIC-10)

Here we can find all Microphones source parameters. That can manage the microphones' inputs like changing the **NAME, GAIN, PAL/PAN, PREAMP, PHASE, PHANTOM 48V**, and many other functions we going to explain briefly below.

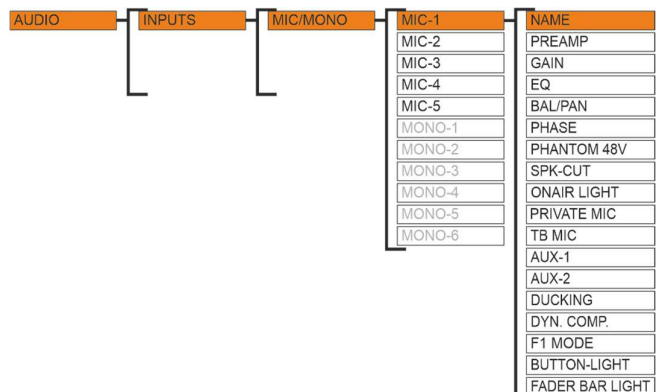
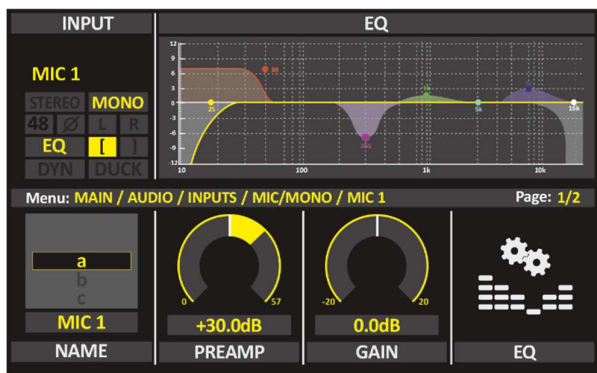
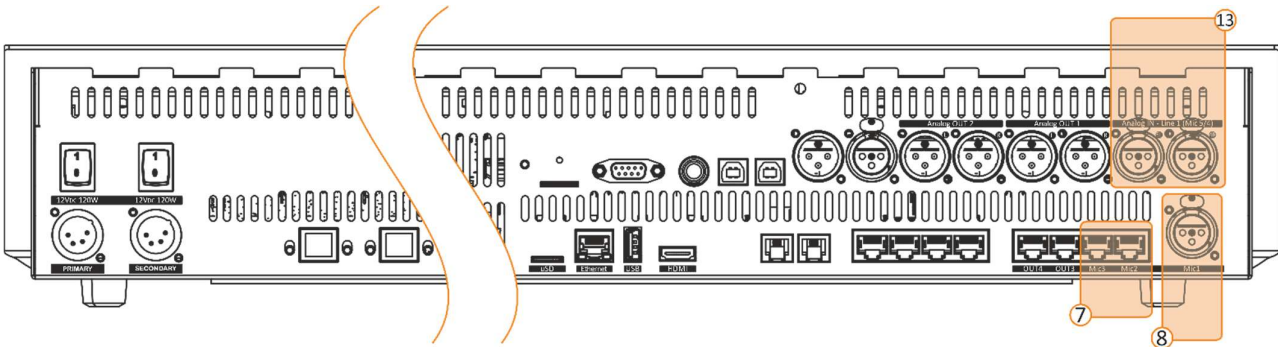

NAME:

This parameter allows the assignment of a **LABEL** to the various input sources.

It is not possible to have a **LABEL** of more than 8 characters.

To change the microphone name and sign it as you like, it's so easy way just rotate and push the knobs.

To end editing the **LABEL**, just push the ESC button.

just follow the next steps. The description works the same for all Inputs. (In the example we are going to set the channel name as (MIC1).

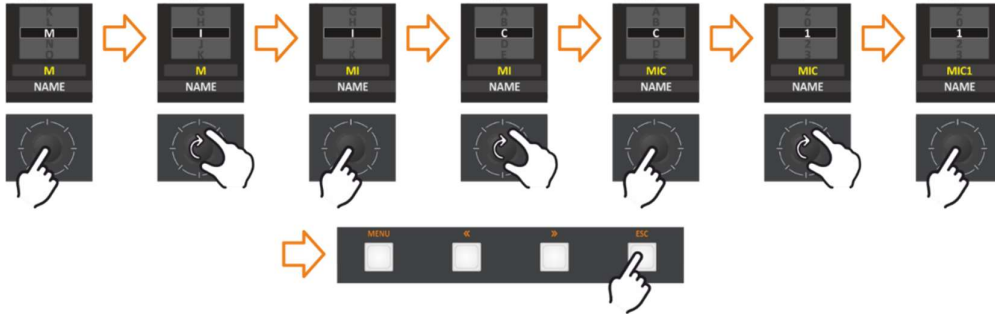

PREAMP:

The preamplifier is typically used to amplify signals from analog sensors such as microphones. It allows you to convert a weak signal for sending to a power amplifier or loudspeaker without any noise or distortion.

This parameter changes the Input **PREAMPLIFIER**.

The parameter has a **0.5 dB** step for a maximum of **57.0 dB**.

N.B.: When you adjust the **PREAMP** parameter, you have a real-time change of the parameter value and a real-time perception of the **PREAMP** change. The Graphics will become white to indicate the parameter change, and they will become yellow again after the confirmation.

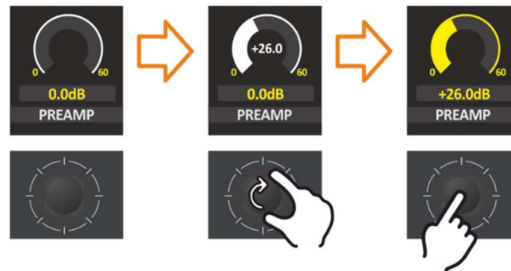

GAIN:

This parameter allows you to adjust the input **GAIN** to bring the source to the right level.

The input Gain has steps of **0.1 dB**.

N.B.: When the parameter control is activated, in real-time the parameter value is updated, perceiving the increase and decrease of the **GAIN**, the graphics will change from yellow to white until the parameter is confirmed.

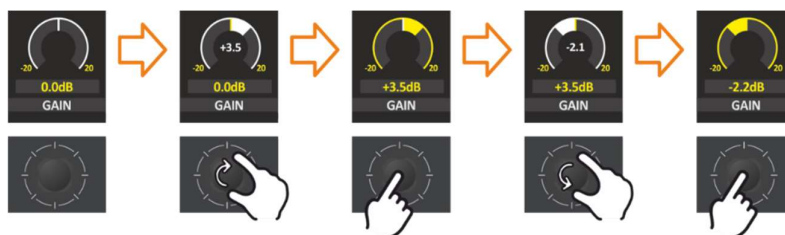

PHANTOM 48V:

This option allows you to turn the phantom power 48V **ON/OFF** for use with microphones (if the microphone requires it, such as a condenser microphone). The Phantom is shown in the **channel Set Panel**.

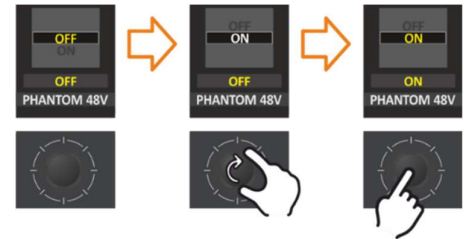

SPK-CUT:

From this function, you can assign the **MIC** to the cut source that has to put the SPEAKERS in mute (**Control Room** or **STUDIO**). it is possible to select one source (**CR, ST**) or both of them together.

The opening of a microphone source (if configured appropriately) can generate the closing command of the loudspeakers.

That is possible to choose one or more sources to cut the loudspeaker.

When you open the associated source with an **SPK-CUT** function, you will see its **MUTE CR** (Control Room) Loudspeakers output and the SPEAKER icon at LCD will start plinking.

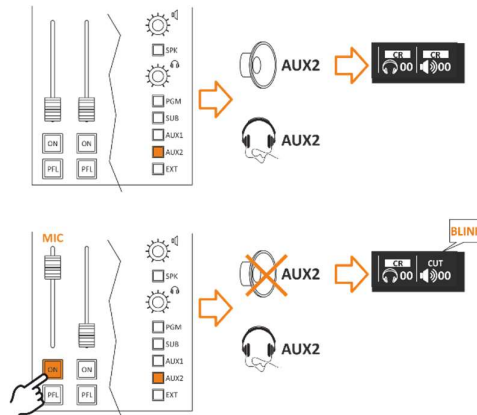

As shown in the MENU this function (**SPK-CUT**) is associated only with the loudspeakers, to avoid **LARSEN effects** “feedback loop” from occurring between the nearby loudspeakers and On-Air microphones.

ONAIR LIGHT:

From here can control the **ON AIR** light through the **GPO** command. If you select **CR** (Control Room ON AIR LIGHT), once this source fader is open, it will activate the **GPO** assigned as **CR-ON AIR**.

To verify if one of 4 GPO is assigned as **CR-ON AIR** can follow this path: -

MENU / MAIN / GENERAL SET. / GPIO / GPO [\[MORE INFO\]](#)

PRIVATE MIC:

The private mic is the microphone that can talk to the caller privately and this conversation is not audible in the loudspeakers and MAIN outputs.

if you press the **PFL** (Pre-Fader Listen) button on the telephone channel, any microphone that is set as a private microphone will be able to communicate with the caller in private, **even if the fader is closed**. This can be useful in situations where you need to have a private conversation with the caller without it being heard ON-AIR audio feed.

TB MIC:

OFF: the microphone is not a Talkback mic. This selection can disable the microphone to disconnect it from the talkback connection.

From CR to ST: talk with the **Studio** using this microphone.

From ST to CR: talk with the **Control Room** via this microphone.

ON MODULE:

from here can select how to but in ON the microphones connected to **TalkBox**, you can choose between FADER & BUTTON, BY FADER, BY BUTTON, ALWAYS ON, and ALWAYS OFF.

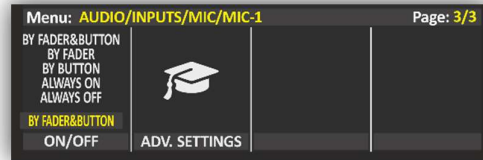

ADV. SETTINGS

EQ:

Parametric EQ: This type of EQ allows you to select a specific frequency to be adjusted with the FREQUENCY knob and adjust the bandwidth of the EQ with the Q knob. The Gain knob allows you to boost or cut the selected frequency.

When adjusting the bandwidth of the EQ, you can choose between a "**Peak**" or "**Shelving**" filter. A Peak filter allows you to adjust the bandwidth of a specific frequency range, while a Shelving filter adjusts the bandwidth of all frequencies above or below a certain point.

These are graphic equalizers that offer a versatile adjustable wide band ranging the spectrum from **22.4 Hz** to **20 kHz**. This equalizer enables the sound to be amplified or reduced in specific frequency bands, which allows for the manipulation of the quality and characteristics of the sound. Furthermore, a maximum boost or cut can be applied to the **LOW-CUT** and **HI-CUT** frequencies.

To **activate** or **deactivate** the EQ for the chosen source, simply press the Equalizer button. To manipulate the **5 frequency bands** (LOW CUT, BASS, BASS-MID, MID, MID-HIGH, HIGH, and HI-CUT), navigate to

MENU / AUDIO / INPUTS / MIC / MIC 1 / ADV. SETTINGS / EQ

Press the menu button (**«**) or (**»**) to switch between the pages of **EQ** types that are available.

Select the specific frequency to be adjusted with the **FREQUENCY** knob, and adjust the bandwidth of the **EQ** with the knob, also you can choose between **PEAK** or **SHELVING** of **BASS** and **HIGH**.

Finally, boost or cut the selected frequency with the **Gain** knob.

After confirming any editing, you will see clearly the change that you do in the graphic equalizer display with different color signals, as well as it is effective at the input source quality and character.

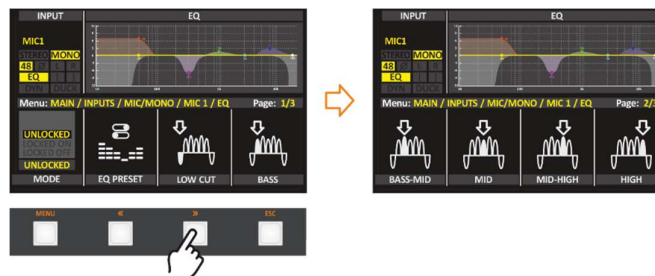

MODE: This function has been added to prevent unauthorized people from activating or deactivating the equalizer.

UNLOCKED: that is mean the equalizer is free and can activate or deactivate the equalizer from the **F** button on the surface.

LOCKED ON: that is mean the equalizer of this channel will be still **ON** and cannot turn off from the **F** button.

LOCKED OFF: that is mean the equalizer of this channel will be still **OFF** and cannot turn ON from the **F** button.

EQ PRESET: This function is useful to save and recall the equalizer settings. These settings are saved in the internal memory and it is not exportable.

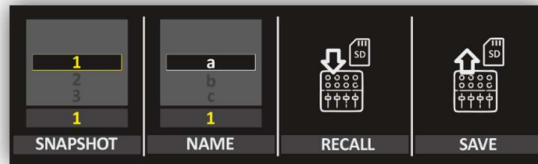

SNAPSHOT: it's able to save ten different **EQ PRESET** by selecting the position of the new save from **1** to **10** before saving it.

NAME: here is can change the name of the PRESET to identify them.

RECALL: to recall one of the PRESETs that are already saved in internal memory.

SAVE: to save the actual equalizer setting as a PRESET.

LOWCUT: This is an audio frequency filter that cuts out all of the low sounds below a certain frequency. On the **OXYGEN** console, you are given knobs to control the frequency of the low cut in a full range from **22.4Hz** to **20.0KHz**. Also, you can control how gradual or steep the cut is. Doing so will eliminate the amplification of unwanted low sound. unwanted sound can be:

- Microphone handling or floor rumble (from bumping the mic or stepping on the floor that the mic stand is sitting on).
- The popping of “**P’s**” and “**B’s**” from a voice.
- Unwanted electrical hum (**60hz**).

When you activate the **LOWCUT** function and confirmed it, that change will appear immediately at the output sources, and it will be shown in **the EQ graphic display as well the LOWCUT mark ([] will change to yellow color.**

HIGH CUT: This is an audio frequency filter that cuts out all of the frequency above which the source signals a certain frequency. manipulates the reflection density in the simulated room.

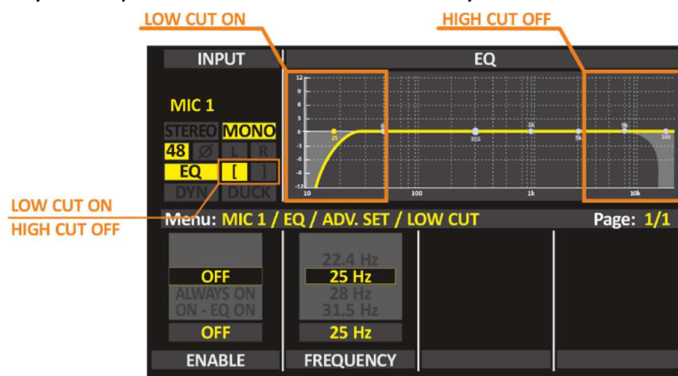

BASS, BASS-MID, MIDDLE, MID-HIGH, HIGH:

In **OXYGEN** the Parametric equalizers allow the adjustment of multi-band frequency equalizers which allow you to control the three primary parameters:

AMPLITUDE, **CENTER FREQUENCY**, and **BANDWIDTH**.

The amplitude of each band can be controlled by the **GAIN** knob.

The center frequency can be shifted by the **FREQUENCY** knob.

Bandwidth (which is inversely related to "Q") can be widened or narrowed by the **Q** knob. **OXYGEN** equalizers are capable of making much more precise adjustments to sound than other equalizers.

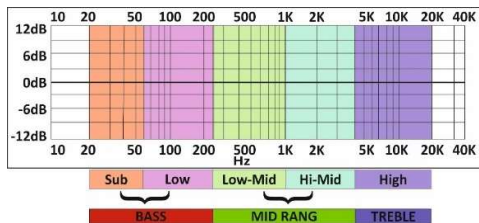

DUCKING:

In the musical programs when it is mixed with a **speech** that needs drop music when the anchorman or the guest starts speaking. the background music instantly drops, then it pops right back up again as soon as that person finishes talking. This happens when the **ducking** effect is in action.

Ducking temporarily lowers, or “ducks,” the volume level of a specified audio signal anytime a second specified audio signal is present. In live sound, ducking is commonly used to lower background music anytime a person speaks, then raises it when that person finishes speaking

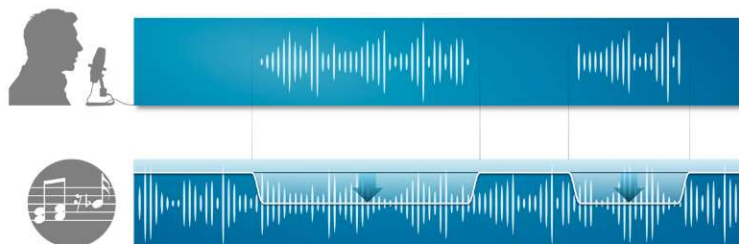

DYN. COMP.:

Dynamic range compression (**DRC**) or simply compression is an audio signal processing operation that reduces the volume of loud sounds or amplifies quiet sounds thus reducing or compressing audio signals in **DYNAMIC RANGE**. Compression is commonly used in sound recording and reproduction, broadcasting, live sound reinforcement, and some instrument amplifiers.

THRESHOLD

A compressor reduces the level of an audio signal if its amplitude exceeds a certain threshold. The threshold is commonly set in decibels (dB), where a lower threshold of **-70 dB** means a larger portion of the signal is treated. When the signal level is below the threshold, no processing is performed and the input signal is passed, unmodified to the output. Thus, a higher threshold of **0 dB**, results in less processing, and less compression.

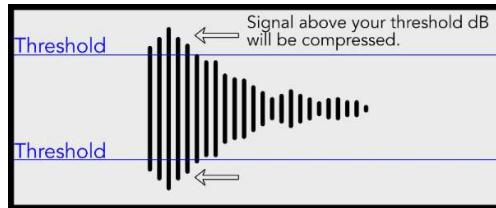

RATIO

When the signal becomes louder than the threshold, the compressor reduces the gain based on the ratio setting. Without getting too mathematical, the ratio of a compressor determines how much gain reduction is applied to a signal after it crosses the threshold.

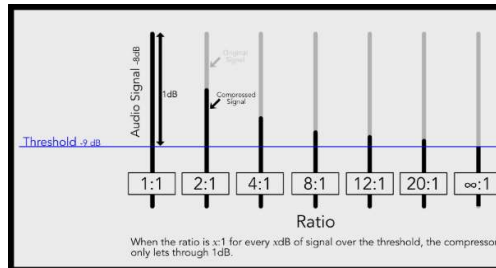

With a ratio of **2:1**, for every **2 dB** above the threshold, the compressor only allows **1 dB** above the threshold through. With a ratio of **4:1**, for every **4 dB** above the threshold, the compressor only allows **1dB** above the threshold through. With a ratio of **10:1**, for every **10 dB** above the threshold, the compressor only allows **1 dB** above the threshold through.

PHASE:

This option was created to control the phase of the microphone by flipping the phase to prevent **PHASE CANCELLATION**. By rotating the knob of the PHASE, you can flip it **180°**.

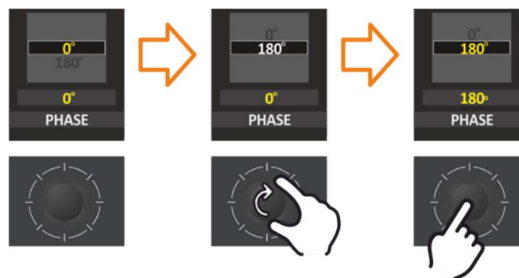

PAN:

This parameter changes the Input **PAN**.

The parameter has a **1.0 dB** step.

N.B.: When you adjust the BAL/PAN parameter, you have a real-time change of the parameter value and a real-time perception of the BAL/PAN change. The Graphics will become white to indicate the parameter change, and they will become yellow again after the confirmation.



F1 & F2 buttons

This feature gives the ability to change the action of the **F button**.

NONE: no action.

TB: By pressing the **F button** can talk privately with the studio in Talkback (**TB**).

It can be set to enable/disable the (COMPRESSOR, DUCKING, and EQ) on this source.

AUX1, AUX2:

From this section, **OXYGEN** gives you the possibility to set **AUX-1** and **AUX-2** to be (**POST FADER**, **PRE-Fader**, or **PRE-FADER ALWAYS ON**) this choice is for every single channel.

When you set **AUX-1** and **AUX-2** to be **PRE-FADER**. The **FADER** does not affect the **AUX** output signal in this case.

When you set **AUX-1** and **AUX-2** to be **PRE FADER ALWAYS ON**. The **FADER** and **ON/START** buttons do not affect the **AUX** output signal in this case.



BUTTON-LIGHT, FADER BAR LIGHT:

Button light LED it's to indicate the channel status.

Fader bare LED indicates the fader level.

From this section, it is easy to change the LED's color and mark it as you want by rotating and pushing the knobs.



MIC AUTOMIX

An automatic microphone mixer automatically reduces the strength of a microphone's audio signal when it is not being used. Automixers reduce extraneous noise picked up when several microphones operate simultaneously.

In the context of sound reinforcement systems, an automixer can be particularly useful for managing spontaneous discussions or panel discussions where multiple participants may be speaking at the same time or interjecting with sudden comments. By using an automixer, the operator can ensure that each participant's voice is heard clearly and that no words or phrases are lost due to **UPCUT** mistakes or lapses of attention.

UPCUT: Chopping off the beginning of the audio or video of a shot or video story. This happens when the editor or technical director doesn't cut to a new audio or video source quickly enough. Opposite of **downcut**.

Overall, while a skilled mixing engineer can greatly enhance the performance of a sound reinforcement system, the use of an automixer can provide an additional layer of support to ensure that all participants are heard clearly and that the audio quality remains consistent throughout the discussion.

To set up the **AUTOMIX**, navigate to [MAIN / AUDIO / INPUTS / MIC / MIC AUTOMIX](#)

MONO / STEREO

RJ45 Female - Balanced Audio Connection (50KΩ). Each 1 stereo can be converted to 2 mono inputs

- 3/6 Stereo Input (L/R)
- 6/12 Mono

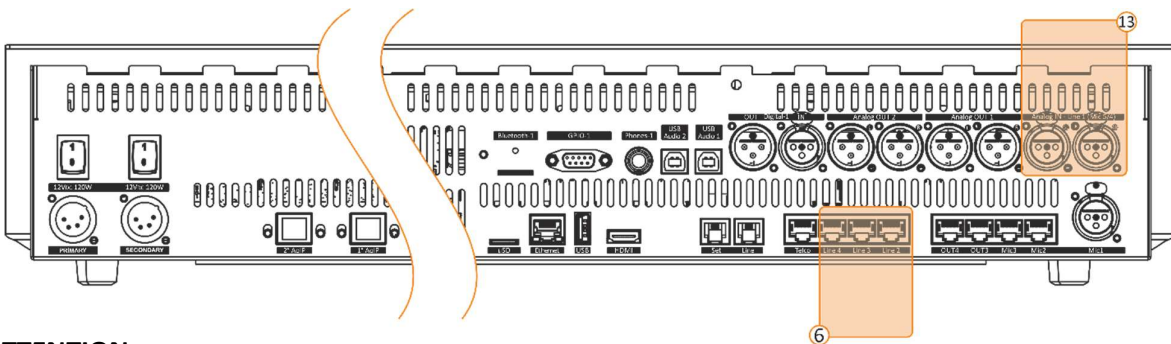

ATTENTION:

When the associated **STEREO** input is active, the **MONO** will be NOT shown in inactive mode.

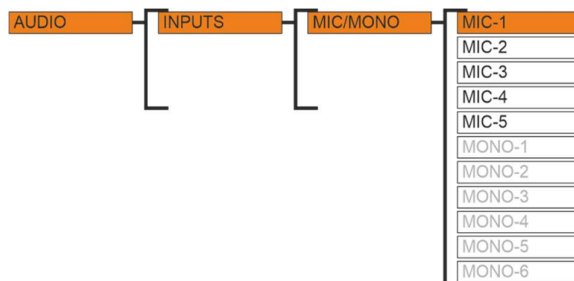

To change the source type from **MONO** to **STEREO** or on contrary you need to follow these steps: -
MENU: MAIN / AUDIO / SETTING / INPUT MODE



From this level of the menu, you choose which input **MONO/STEREO** source you like to customize.
MENU: MAIN / AUDIO / INPUTS / (MONO or STEREO)



INPUTS SETTING (MONO/STEREO)

Here we can find the source parameters (**MONO/STEREO**)

That can manage our inputs like changing the **NAME, GAIN, PAL/PAN, EQ, AUX-1, AUX-2, BUTTON LIGHT,** and **FADER BAR LIGHT.**

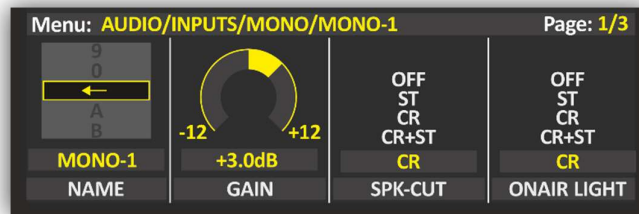

OXYGEN gave you the possibility to set **AUX-1** and **AUX-2** to be **POST-Fader** or **PRE-Fader**, this choice is for every single channel.

ATTENTION: When you set **AUX-1** and **AUX-2** to be **PRE-Fader**. The FADER does not affect the AUX output signal in this case.



USB AUDIO

2 USB audio interface per each board

The USB audio interface allows you to directly connect the PC to the **Oxygen** console, with no need for audio cards. In fact, the PC detects the console as a digital audio card with 2 stereo inputs and 2 stereo outputs for simultaneous playout and recording (**Bidirectional**).

two Built-in stereos **USB I/O** Audio Interface to connect directly to a computer. USB Audio Card with a connector **Type-B**. With this type of connection, you can save hundreds of dollars on an audio card. By **OXYGEN** Digital Mixing Console, you can connect your computer or any digital device via perfect USB audio I/O sources.

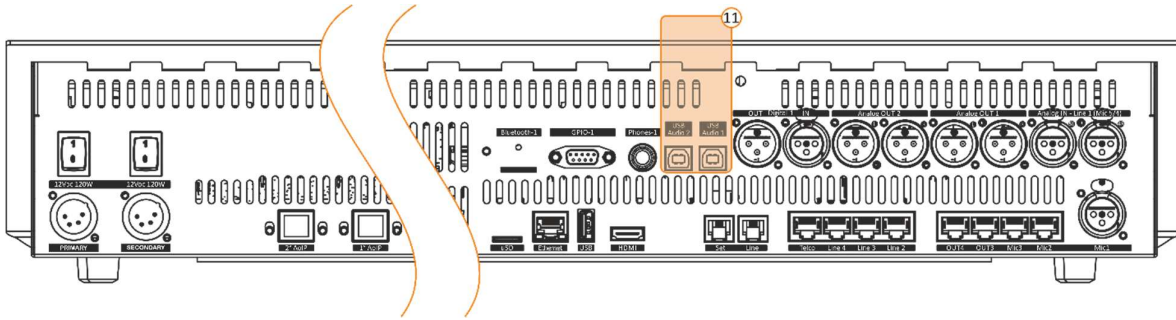

Once the mixer is connected to a computer, it will be recognized automatically and will not require any intervention. The connection is made via a normal **USB-B cable 2.0**

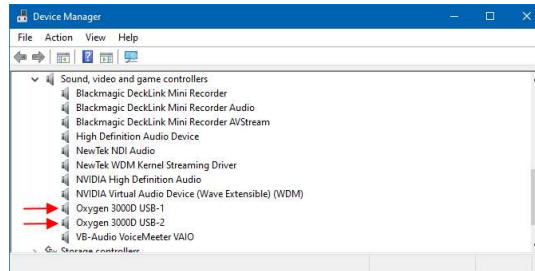

NOTE: Highly recommend that not use a (SS 10) SUPERSPEED USB port on the PC side.



To set the parameters correctly, set the **input/recording** and **output/playback** as default (**48000 Hz**).

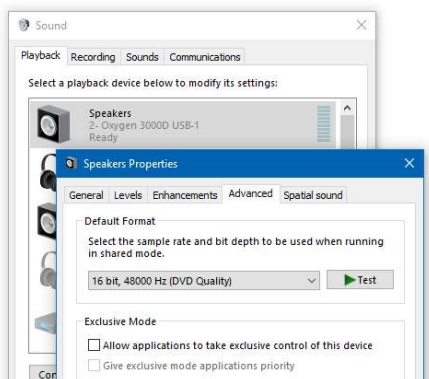

DIGITAL AES/EBU

OXYGEN Digital Mixing Console has included digital audio input sources. The digital audio can connect to any digital audio source via **AES/EBU**. Stereo Input - **XLR Female** - Balanced Digital Connection (**110Ω**).

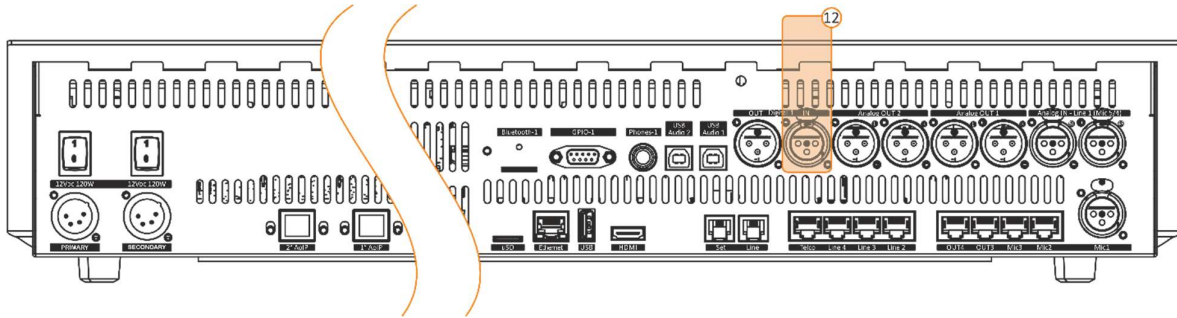

DANTE*

DANTE AUDIO-OVER-IP CONNECTIVITY (Optional)

Dante option (compliant with AES67) provides an Ethernet connection for **32 or 16 Stereo Input** and **32 or 16 Stereo Output**, with independent and dedicated Level Control and Sample Rate Conversion.

[HTTPS://DEV.AUDINATE.COM/GA/DANTE-CONTROLLER/USERGUIDE/PDF](https://dev.audinate.com/ga/dante-controller/userguide/pdf)

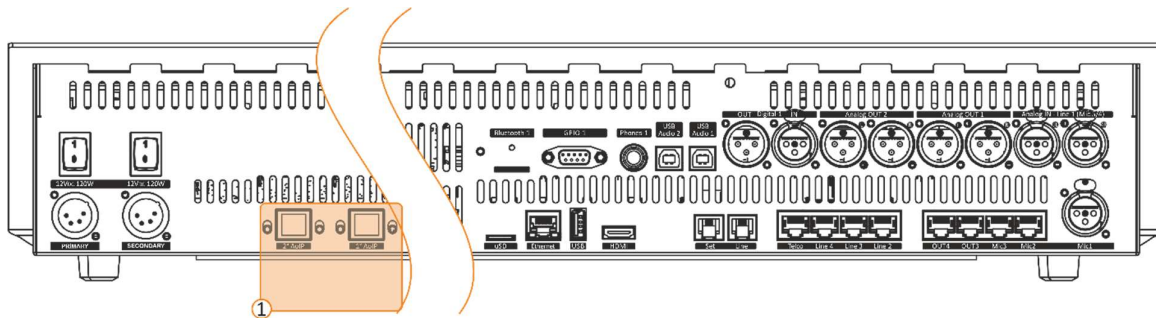

The **primary LAN** port is the main network connection on a device.
The **secondary LAN** port is not available.

* Optional.

PHONE / TELCO / BT (Bluetooth)

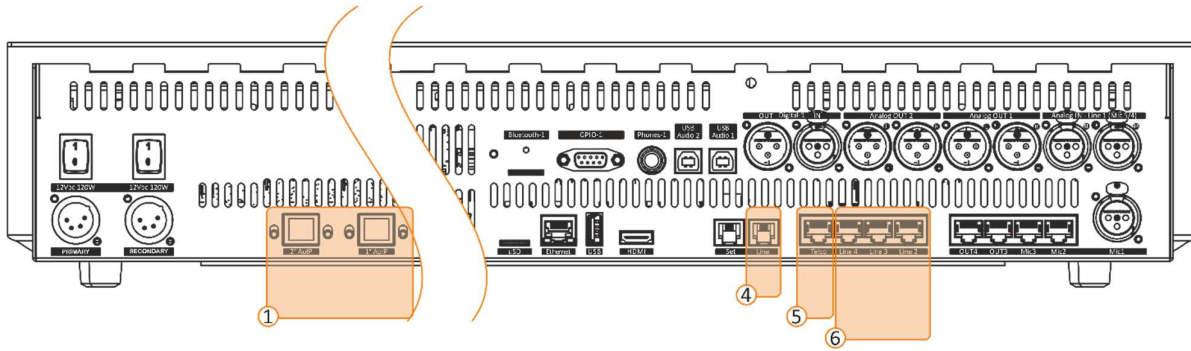

Each of the aforementioned sources possesses the capability to function as a TELCO source for the **N-1** function. In the event that there is a requirement to establish connections with more than one TELCO, it is possible to easily convert **LINE 2** and **LINE 3** to accommodate two TELCOs per line, and in addition to this, it is feasible to configure the 8 Dante sources as TELCO inputs. This will yield additional TELCO inputs.

To use the internal hybrid in **OXYGEN**, connect the telephone line to the console RJ11 **LINE** port and the telephone set to the RJ11 **SET** port in the console.

If you want to connect the TELCO MODULE with one of the **Axel** telephone hybrids (**BOXTEL MKII**, **MACROTEL X1 X2**, **PHONEX D1 D2**) it is very easy to do the TELCO commands via standard DB9P connector. It is also possible to communicate with the external hybrid via GPIO over IP.

These three different kinds of implementations were been grouped all together. In fact, they have similarities on the source side.

3 kind of telephone connection is available on the full version of the **OXYGEN 3000 Plus** Digital console:

- **2x TELEPHONE** (internal telephone 📞 hybrids)
- Up to **12 TELCO** (external telephone 📞 hybrids)
- **2x BLUETOOTH** (smartphone 📱 call & player)

The **built-in telephone hybrid** allows direct connection of a telephone line **POTS/PSTN** on **RJ-11C**. The audio is processed via DSP which delivers state-of-the-art audio processing. **TLC** commands are available on a **SubD** connector with Hook and Ring interface for an external telephone hybrid or via GPIO over IP.

If the line is well connected, you have to associate the **TELEPHONE IN** source to a Mixer Channel. When you will receive a phone call press the **F button** of the selected Channel to hook the line.

In the presence of an incoming call, the **F button starts blinking**.

By pressing **F** it will hook the call.

- F LED **off** – the line is not hooked.
- F LED **blinks** – RING – there is an incoming call.
- F LED **on** – the line is hooked.

By pressing **F** again you drop the line.

NOTE: The behavior of (RING/HOOK) is the same for the three interfaces (TELCO, HYBRID, and BLUETOOTH).

F button MODE:

From here, you can change the way the **F** button communicates with the external hybrid and can select one of three choices available (**NONE**, **GPIO**, **DEVICE**)

NONE: no action.

GPIO: F button communicates with the external TELEPHONE HYBRID by the traditional general-purpose Input/Output.

DEVICE: The F button communicates with the external TELEPHONE HYBRID by the **GPIO over IP**. That gave the possibility to communicate with an external telephone hybrid via ethernet.

PRIVATE MIC

To initiate a private conversation with a caller, one must press the **PFL** button located on the TELEPHONE line channel. The input dedicated to facilitating communication with the caller is referred to as **PRIVATE MIC**. Similar to the Talkback feature, the PRIVATE MIC input is not subject to control by the **ON/START** button or the fader level. It is the designated microphone that facilitates confidential communication with the caller, and the conversation that transpires through this input remains inaudible in the loudspeakers and MAIN outputs. It is possible to configure one or more private microphones to enable communication with the caller.

By pressing **PFL** (in the telephone channel) you can speak in private to the radio listener (caller) from each microphone that has the private mic function ON.

To set the private mic ON, navigate to **MENU: MAIN / AUDIO / INPUTS / MIC / PRIVATE MIC (ON)**



That can control the **GAIN TX** from the menu to decrease or increase the TX audio gain “output to the caller”. It’s easy to adjust it between **-20 dB** to **20 dB** by rotating the **GAIN TX** knob. The step of the adjustment is **0.1 dB**.



INTEGRATED HYBRID LINE

You can directly connect a **POTS/PSTN** phone line to the OXYGEN back panel through the **RJ11** connector called **TELEPHONE LINE**.

Before sending the phone call **ON AIR**, it is also possible to manage the phone call through the parallel POTS/PSTN phone device connected to the next **SET** port on the **RJ11** connector.

The following parameter setting:

MAIN / AUDIO / INPUTS / PHONE / TELEPHONE 1 / ADV. SETTINGS

lets you assign the **HOOK / DROP** function to the related **F** button. This parameter only affects the channel on which you have assigned the TELEPHONE source (so TELCO, BLUETOOTH will not be affected).

EXTERNAL TELCO DEVICE

A phone call could be managed by an external **TELCO DEVICE**. To use the device with the console you have to connect the external hybrid to:

- the **RJ45** connector to the related port labeled as **TELCO I/O GPIO**.
- the **RJ45** connector **LINE** port and change the input mode to **2 TELCO** from **MAIN / AUDIO / SETTINGS / INPUT MODE / AUDIO 1 or 2** [\[MORE INFO\]](#)
- Via **DANTE** and change the related channel mode to de as **2 TELCO** from **MAIN / AUDIO / SETTINGS / INPUT MODE / DANTE** [\[MORE INFO\]](#)

The correct cable **pin-out** to be used with the **TELCO RJ45 port** is described in the **+188-RJ45-TELCO** scheme. [\[MORE INFO\]](#)

from this **TELCO I / O GPIO** port can get 4 different signals carried: **2 audio-mono** signals of the phone call input and output and **2 general purpose** electrical signals.

- mono **Telco INPUT** signal.
- mono **Telco OUTPUT** signal (designed with the **clean feed / N-1** technology avoiding the INPUT signal return)
- **GPI** signal coming from the external TELCO device.
- **GPI** signal forwards to the console the **RING** signal from the external device.
- **GPO** signal outcoming towards the external **TELCO** device.
- **GPO** signal forwards the **HOOK** command to the external device.

MAIN / AUDIO / INPUTS / PHONE / TELEPHONE 1 / ADV. SETTINGS

lets you assign the **HOOK / DROP** function to the related **F button**. This parameter only affects the channel on which you have assigned the TELEPHONE source (so TELCO, BLUETOOTH will not be affected).

TELCO 1 GPIO SETTINGS

The GPIO settings for this primary TELCO device are settable by this OXYGEN REMOTER sub menu

MAIN / GENERAL / GPIO

To manage TELCO 1 GPI signal set the TELCO 1 RING by the following submenu:

MAIN / GENERAL / GPIO / GPI / TELCO 1

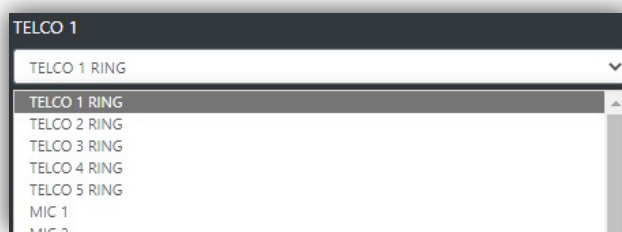

To manage TELCO 1 GPO signal set the TELCO 1 HOOK by the following submenu:

MAIN / GENERAL / GPIO / GPO / TELCO 1

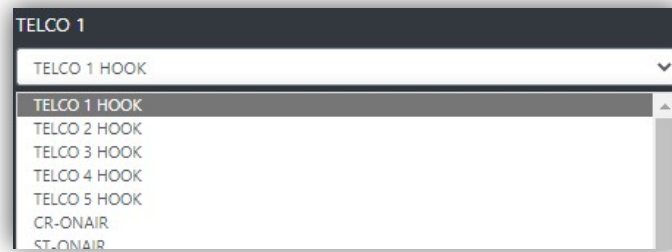

ADDITIONAL TELCO LINES

It is possible to use 4 more additional TELCO lines (TELCO 2 / TELCO 3 / TELCO 4 / TELCO 5) by setting the console with the correct parameters.

ADDITIONAL TELCO INPUT

ANALOG-IN-1 could be configured as 2 different mono TELCO inputs:

TELCO 2: ANALOG-IN-1-L

TELCO 3: ANALOG-IN-1-R

to use the 2 above signals as 2 separate telco input lines please set the related parameter as follow:

MAIN / AUDIO / SETTINGS / INPUT MODE / LINE 1 MODE = 2 TELCO

after this setting, the choosable source will be no more only ANALOG-IN-1 but the 2 input signals will be labeled in the source list as TELCO 2 and TELCO 3.

DANTE-IN-1 could be configured as 2 different TELCO mono inputs:

TELCO 4: DANTE-IN-1-L

TELCO 5: DANTE-IN-1-R

NB: If your console does not have the DANTE option you can not have TELCO 4 and TELCO 5. The only available additional TELCO will be TELCO 2 and TELCO 3.

to use the 2 above signals as 2 separate telco input lines please set the related parameter as follow:

MAIN / AUDIO / SETTINGS / INPUT MODE / DANTE 1 MODE = 2 TELCO

ADDITIONAL TELCO OUTPUT **clienfeed / N-1 logic**

OUT-2 (ANALOG-OUT-2) source could be configured as 2 different TELCO mono outputs:

TELCO 2: ANALOG-OUT-2-L
 TELCO 3: ANALOG-OUT-2-R

to use the 2 above signals as 2 separate telco output lines please set the related parameter as follow:

MAIN / AUDIO / OUTPUTS / ANALOG / OUT-2 / source

N-1 T2/T3: TELCO 2 caller and TELCO 3 caller can hear each other.
N-1 T2+T3: TELCO 2 caller and TELCO 3 caller can not hear each other.

DANTE-OUT-1 could be configured as 2 different TELCO mono outputs:

TELCO 4: DANTE-OUT-1-L
TELCO 5: DANTE-OUT-1-R

to use the 2 above signals as 2 separate telco output lines please set the related parameter as follow:

MAIN/AUDIO/OUTPUTS/DIGITAL/DANTE-1/ source

N-1 T4/T5: TELCO 4 caller and TELCO 5 caller can hear each other.
N-1 T4+T5: TELCO 4 caller and TELCO 5 caller can not hear each other.

USABLE GPIO FOR THE ADDITIONAL TELCO LINES

If the GPIO port is not already used, it is possible to implement a GPIO communication with all of the additional external TELCO devices by using the GPIO port.

The SUB-D9 pin-out is described in the GPIO PINOUT scheme, resumed by the picture below:

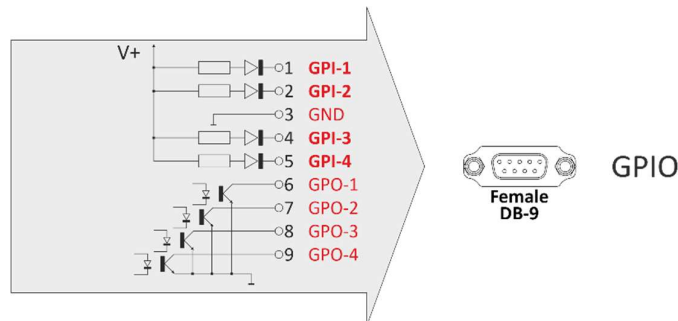

In this previous scheme is described the pinout of this **SUB D9** connector.
 Each **GPI** and each **GPO** is manageable from the menu.

[MAIN / GENERAL SET. / GPIO](#) [MORE INFO]

Bluetooth

Oxygen has a Bluetooth connection. This allows airing the calls made via **Skype, Teams, Whatsapp**, or normal phone calls by a Smartphone 📱 and Tablet.

Oxygen has two modes of Bluetooth connection:

- **Mono Bidirectional** to support phone calls.
- **Stereo monodirectional** for streaming high-quality stereo audio (**A2DP**). This feature allows airing music from smartphones and tablets.

The device is in pairing mode after a fast press (< 1 sec) of the Bluetooth button. It starts to blink in blue color.



Search for the **Oxygen XXXX** in a Bluetooth device and connect with it. Once the device is connected the blue light stops blinking.



Rotate the desired **knob** and search for Bluetooth in the source menu (for example knob of the 4th channel).



Press the desired BUS on the channel (for example **PGM**).



start the audio streaming (music, audio from YouTube/Music Player) or the phone call (Call, Skype, WhatsApp,) from the Bluetooth device.

If you turn on again the Bluetooth in the device and if the device is still associated with the console, it will be automatically paired. You will see a fixed blue light. The console is included **RN52 Bluetooth Audio Module**.

Note: For the module certifications, check this website please:

[HTTPS://WWW.MICROCHIP.COM/WWWPRODUCTS/EN/RN52](https://www.microchip.com/wwwproducts/en/RN52)

STREAMER

OXYGEN combines the capabilities of an audio **encoder** and **decoder**, which are used to compress and decompress audio signals respectively, with the ability to stream audio data over a network or the internet. This integration allows for the efficient transmission and reception of high-quality audio data in real time.

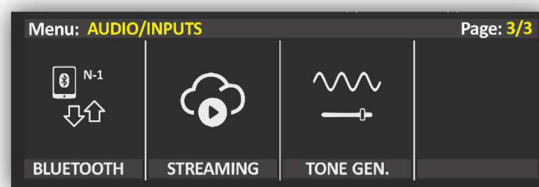

To configure the streaming sources **ENCODER** and **DECODER**, please check the WEB interface user manual.

TONE GEN.

OXYGEN Digital Console comes with a built-in audio tone generator. The tone range is **30 Hz - 20 kHz** and you can select it by following these steps: -

MENU: MAIN / AUDIO / INPUTS / TONE GEN.

This option is too useful for tuning instruments, science experiments, and testing audio equipment (how low does my subwoofer go?).



4.1.3. OUTPUTS

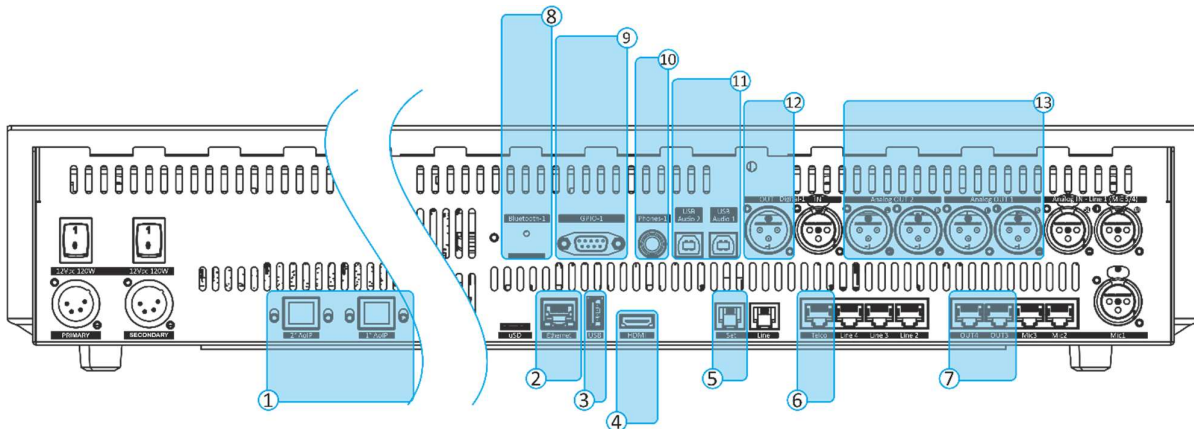

OXYGEN Digital console is coming with variant audio output connectors like **XLR, JACK, USB, and RJ45** to give you maximum flexibility with your instruments and your project cabling. With all those functions you can save time and money. As well as the creative USB connection and Dante technology, we don't need a sound card or a professional instrument to connect any media player or recorder like a **PC, Workstation, or laptop**.

OXYGEN outputs included:

- **2 Stereo XLR Male** - Balanced Audio Connection (**47Ω**).
- **2 Stereo RJ45 Female** audio and **GPIO** connections.
- **1 Telco I/O RJ45 Female** audio and **GPIO** connections.
- **1 Analog Telephone Line - RJ11 - PSTN** Interface
- **1 AES/EBU Stereo XLR Male** - Balanced Digital Connection (**110Ω**).
- **32 Stereo RJ45 Female** DANTE audio.
- **2 USB Audio Card USB -Type B** - PC Connections.
- **1 Stereo Output - Jack 6.3mm** - Unbalanced Audio Connection (**nominal 32Ω**).

You can set output parameters from the **MENU: MAIN / AUDIO / OUTPUTS** by **PUSH/RUTATE** the knobs as in the following steps.

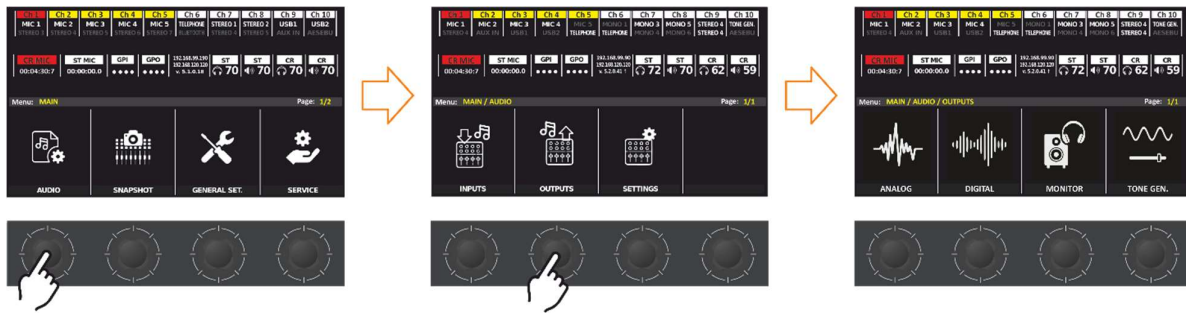

From this level of the menu, you choose which output you like to customize.

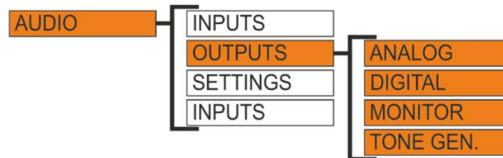

ANALOG & DIGITAL outputs.

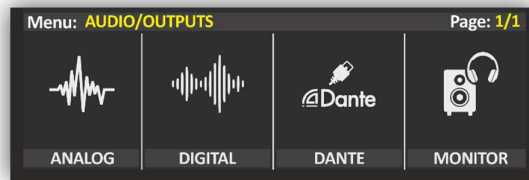

From this level of **MENU**, you can customize the main outputs. In this section, you can select the main output source type, gain, and mode.

It's also able to adjust the audio output level with the **GAIN** knob. The gain has steps of **0.1 dB**. The audio output **GAIN** range goes from **-6 dB** to **6 dB**. From **MODE** can select the output type like **STEREO**, **MONO**, **MONO LEFT**, or **MONO RIGHT**.

N.B.: When the parameter control is activated, in real-time the parameter value is updated, perceiving the increase and decrease of the **GAIN**, the graphics will change from yellow to white until the parameter is confirmed.

DANTE OUT

The source of these **DANTE outputs** is selectable by the user by choosing a different logical BUS between PGM/SUB/AUX-1/AUX-2 or by selecting one of the monitoring signals SPK-CR/HDP-CR/SPK-STD/HDP-STD, or by using it as a cleanfield/**n-1** channel for the additional **TELCO** devices. The **TONE GEN.** has only test purposes for the audio output.

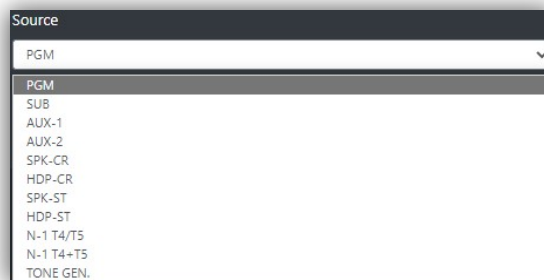

GAIN

This cursor adjusts the output GAIN of the current DANTE output.

The parameter has a **0.1 dB** step for a minimum of **-6.0 dB** to a maximum of **+6.0 dB**.

The default value is **0.0 dB**.

MONITOR (SPK & HDP)

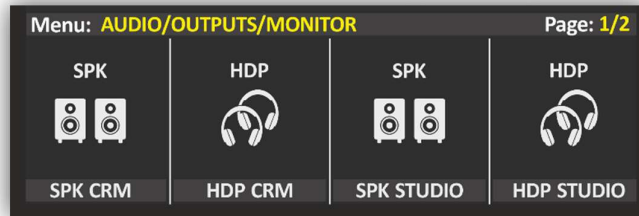

From this level of **MENU**, you can customize the main outputs. In this section, you can select the main output source type, gain, and mode.

It's also able to adjust the audio output level with the **GAIN** knob. The gain has steps of **0.1 dB**. The audio output **GAIN** range goes from **-6 dB** to **6 dB**. From **MODE** can select the output type like **STEREO**, **MONO**, **MONO LEFT**, or **MONO RIGHT**.

N.B.: When the parameter control is activated, in real-time the parameter value is updated, perceiving the increase and decrease of the **GAIN**, the graphics will change from yellow to white until the parameter is confirmed.

SETUP / AUDIO / OUTPUTS / MONITOR [\[MORE INFO\]](#)

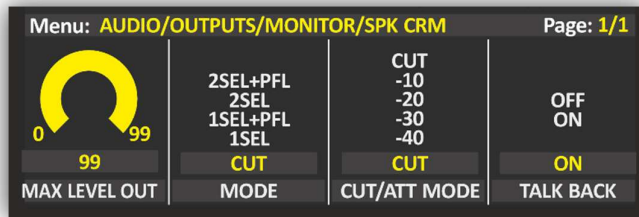

MAX LEV OUT

It is possible to limit the maximum audio level of the current Loudspeaker or Headphones output in the case current loudness is too high for the needs. By adjusting this cursor you will be able to reduce the allowed **MAX LEV OUT**. The parameter has a **1 %** step.

for a minimum of **0 %** to a maximum of **99 %**. The default value is **99 %**.

MODE

[\[MORE INFO\]](#)

CUT/ATT MODE

[\[MORE INFO\]](#)

TALKBACK

Control Room (CRM)

Loudspeaker (SPK) and Headphone (HDP) (OFF, ON)

Here you can **disable/enable** the **TALKBACK** communications in control room speakers. Normally the talkback is used to communicate between the mixer man and the people in the studio via headphones or speakers or vice-versa. This option gives you the possibility to hear the people talking in TALKBACK from the studio to the Control Room through Control Room speakers.

OFF: no talkback talks will be heard.

ON: talkback talks will be heard.

STUDIO

Loudspeaker (SPK) and Headphone (HDP) (OFF, TB1, TB2, TB1+TB2)

Here you can **disable/enable** the **TALKBACK** communications in studio speakers. Normally the talkback is used to communicate between the mixer man and the people in the studio via headphones or speakers or vice-versa. This option gives you the possibility to hear the people talking in TALKBACK from the Control Room to the STUDIO through Studio Speakers.

OFF: no talkback talks will be heard.

TB 1: Only talks directed to TB1 will be heard.

TB 2: Only talks directed to TB2 will be heard.

TB1+TB2: The talk messages directed to TB1 or TB2 will be both heard.

4.1.4. CHANNELS

ENABLE VIRTUAL CHANNELS

Oxygen consoles have the peculiarity of being able to use, at the complete discretion of the user, up to 8 additional Virtual Channels. It is possible to configure the virtual channels from the **OXYGEN REMOTER**.



No: The OXYGEN REMOTER will display only the standard Physical Channels.

Yes: By selecting this Yes option, the user enables the possibility to add up to 8 VIRTUAL CHANNELS. To learn more about this function, please consult the related **Errore. L'origine riferimento non è stata trovata.** chapter of this **OXYGEN REMOTER** User Manual.

[HTTPS://WWW.AXELTECHNOLOGY.COM/PUBLIC/OXYGEN3000D/MAN-OXYGEN%20REMOTER-EN.PDF](https://www.axeltechnology.com/public/oxygen3000d/man-oxygen%20remoter-en.pdf)

Also, you can find here a small video tutorial about how to add VIRTUAL CHANNELS.

[HTTPS://WWW.YOUTUBE.COM/WATCH?V=I3DQZ6ZIXEQ](https://www.youtube.com/watch?v=I3DQZ6ZIXEQ)

4.2. SNAPSHOT

This function is useful to save and recall the settings. These settings are saved in the internal memory and it is not exportable. [\[MORE INFO\]](#)

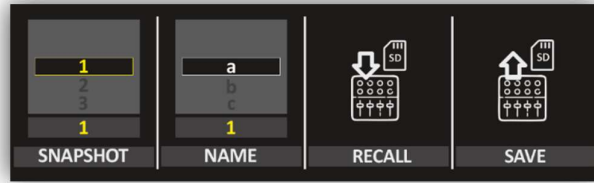

SNAPSHOT: it's able to save ten different PRESETS by selecting the position of the new save from **1** to **10** before saving it.

NAME: here is can change the name of the PRESET to identify them.

RECALL: to recall one of the PRESETs that are already saved in internal memory.

SAVE: to save the actual setting as a **PRESET**.

4.3. GENERAL SET.

4.3.1. GPIO

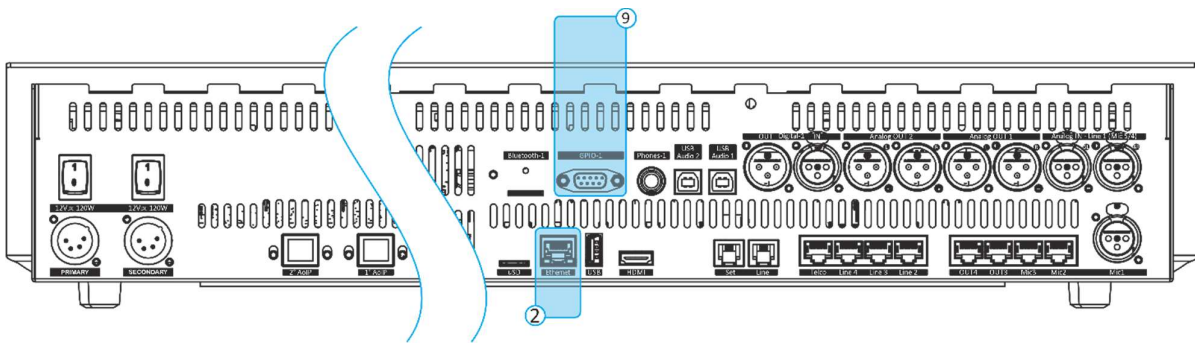

Here we will talk about only the physical **GPIO** connections. You can find the **GPIO over IP** in the **TELCO** part. [\[MORE INFO\]](#)

The full version of **OXYGEN** comes with two SUB-D 9pin (female DE-09) as a connector of general-purpose input/output (**GPIO**). Each one of these two connectors is equipped with two programmable **GPI** and two programmable **GPO**.

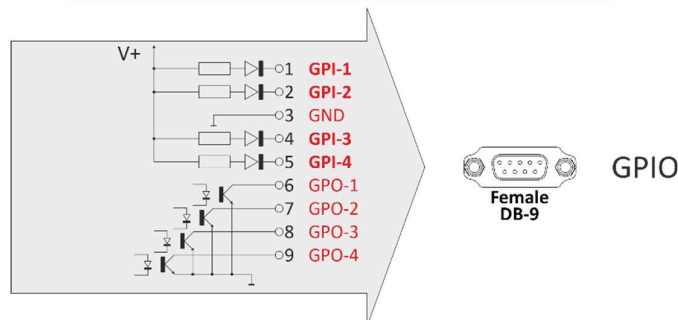

4.3.2. COMMUNICATIONS

From the **GENERAL SET** part of the menu, you can set the communication parameters like **IP, DNS, Date & Time, Time zone, and NTP server**. The high flexibility in **OXYGEN Digital** console design gives you the full ability to set this terrific console as you like and as your audio projects are needed. For example, **OXYGEN** comes with two **TCP/IP** connections. One of them is for monitoring, **WEB INTERFACE, REMOTE CONTROL,** and data source (**NTP server**), and the second one we can use to connect our console with other machines or software like **VJ PRO**.

TCP-IP

From the following pictures, you can see how to set the parameters for all the menus: **IP, MASK, and GATEWAY**. We will explain only one of these cases: the IP settings. The other cases work in the same way. By rotating the 4 encoders you can set a new IP Address. Every encoder goes from **0** to **255**. By pressing the encoder, you can confirm your choice.

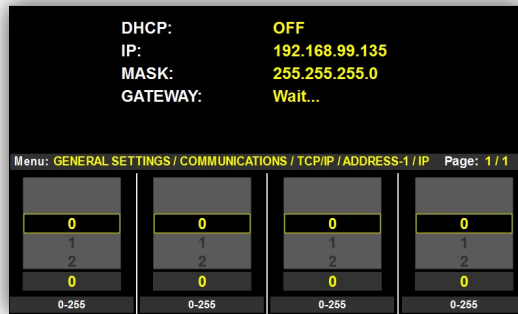

TIME & DATE

From the **General SET. / Communications / TIME&DATE** you can configure all parameters related to time and date.

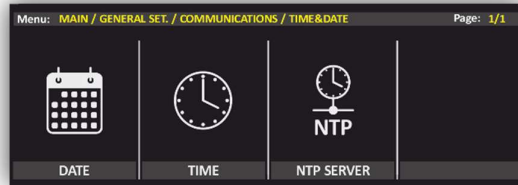

TIME

From the following section, you can set all the parameters related to the date settings. These data parameters are very important for device **LOGS**.

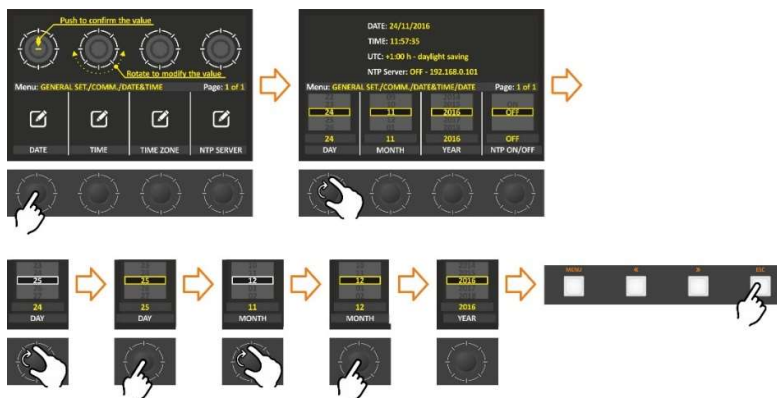

TIME ZONE

From this parameter, you can set the TIME ZONE. You can set the right Offset to the UTC time.

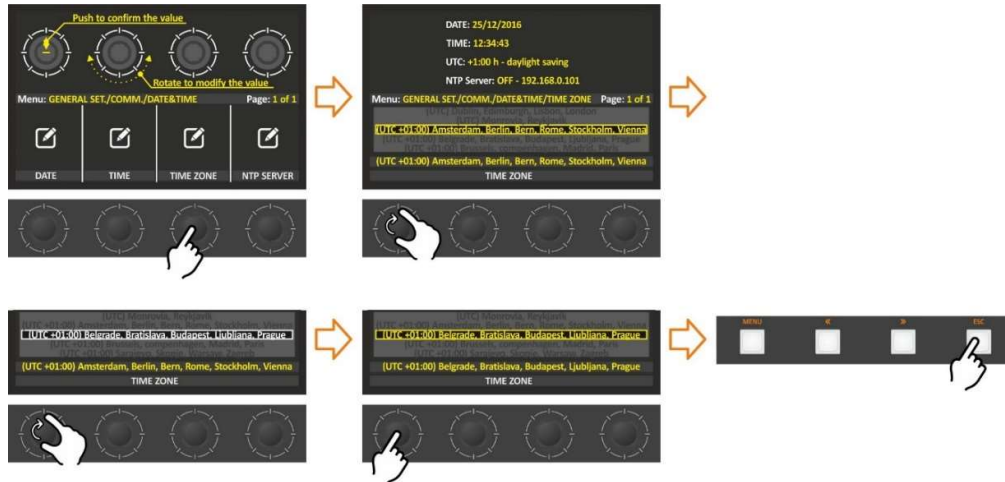

NTP

Network Time Protocol. This section contains all the settings related to **NTP** features. It is, in fact, possible to connect the device to an **NTP server**, and in this way, the device will synchronize its own date and time with the server.

NTP Server in the world:

- europe.pool.ntp.org (217.147.223.78)
- asia.pool.ntp.org (140.130.175.9)
- oceania.pool.ntp.org (203.23.237.200)
- north-america.pool.ntp.org (66.250.45.2)
- south-america.pool.ntp.org (146.164.53.65)
- africa.pool.ntp.org (196.25.1.9)

4.3.3. ACCESS CODE

The Oxygen console gives the user the ability to lock the settings with a passcode to prevent any modifications by unauthorized persons. There are two different Access Codes (**4-digit PIN**) to help you if one of the **two passcodes** is forgotten.

- **Two** different Passcode
- The default passcode is **0000**
- It can disable and enable both of them together by **ON/OFF** selection.
- Can set the passcode to lock the display after **10, 30, or 60 minutes**.

ENABLE: If **No** is selected, the console will never be locked. If **Yes** is selected, the console will be locked after the Unlock Time selected in the last parameter of this section. After the Unlock Time, the console needs **CODE1** or **CODE2** to be unlocked successfully.

CODE1: here you can set the primary desired code to Unlock the console after Unlock Time will be passed.

CODE2: here you can set the secondary desired code to Unlock the console after Unlock Time will be passed.

UNLOCK TIME: Select between the available options the time after you want the console will be automatically locked. Choosable options are **10 min, 30 min, and 60 min**.

4.3.4. LIGHT & DISPLAY

From the following menu sub-sections, you can set the led colors and the led brightness. It is also possible to choose between the different HDMI output layouts available.

From the following menu, you can set the display light and the led brightness.

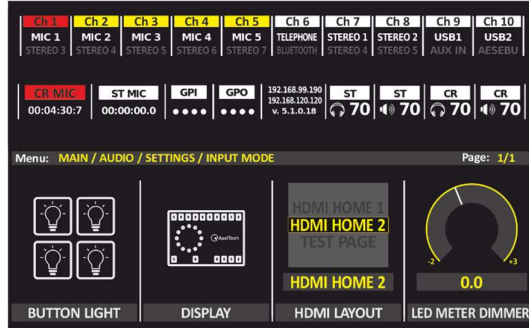

BUTTON LIGHT

in this section can set the light intensity of buttons. Also, it can set a different color for **MUTE**, **PFL**, and **MENU**.

That is also **4 editable colors** (color-1 to 4)
An RGB color value is specified with RGB (red, green, blue).

Each parameter (**red**, **green**, and **blue**) defines the intensity of the color as an integer between **0** and **255**.

For example, RGB (**0**, **0**, **255**) is rendered as **blue**, because the **blue** parameter is set to its highest value (**255**) and the others are set to **0**.

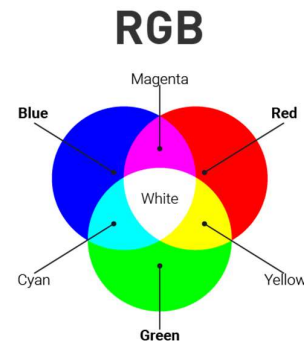

Just for example:

| | | | | | | | | | | | | |
|---|-----|-----|-----|-----|-----|-----|-----|-----|-----|-----|-----|-----|
| R | 255 | 255 | 255 | 125 | 0 | 0 | 0 | 0 | 0 | 125 | 255 | 255 |
| G | 0 | 125 | 255 | 255 | 255 | 255 | 125 | 0 | 0 | 0 | 0 | 0 |
| B | 0 | 0 | 0 | 0 | 0 | 125 | 255 | 255 | 255 | 255 | 255 | 125 |

DISPLAY

From here, the display screen can be dimmed, and change the HOME view style. also, it is possible to load the logo to be viewed on the main screen.

To have the logo of your own station on the Mixer display. The image must be **330x280px** in **PNG** format and named **logo.png** then put this logo on the USB memory stick and insert it in the USB port at the rear of the mixer. click on **READ USB** to load it.

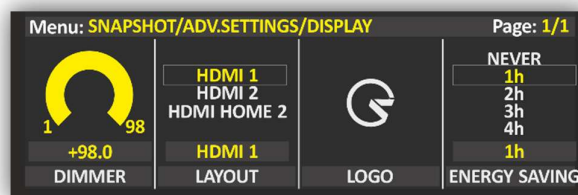

The Oxygen console allows you to set and manage 2 different kinds of outgoing IP commands:

- The first **SMART KEY** kind could be managed by Oxygen **FUNCTIONS** buttons.
- the second **TRIGGER** kind could be managed by OXYGEN channel sliders and related ON/OFF buttons.

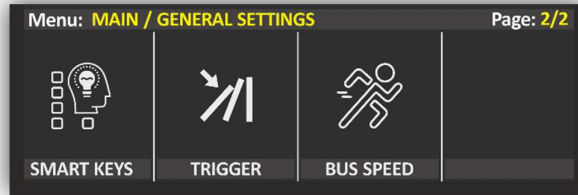

4.3.5. SMART KEYS

By clicking one of the **FUNCTIONS** buttons (from **K1** to **K8**) you can automatically send a **TCP**, **UDP**, or a **Rest API** Command to a remote application/device compatible with these 3 different communication protocols (For example, your Automation Software).

Each Smart Key could control the remote software by **IMPULSIVE** or **TOGGLE**.

IMPULSIVE: One Button Pressure (click).

TOGGLE: Two Button Pressure (first pressure for **ON** and second pressure for **OFF**). when clicked remains "down" (appearing to be pressed) until it is clicked again.

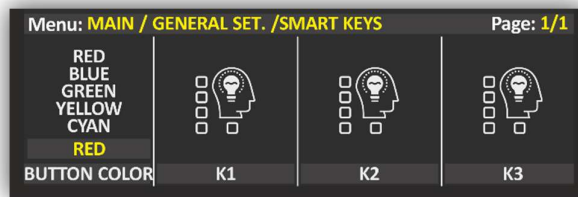

For more information about how to configure the **SMART KEYS**, please check the OXYGEN REMOTER MANUAL.

<https://www.axeltechnology.com/public/oxygen3000d/man-oxygen%20remoter-en.pdf>

4.3.6. ONAIR TRIGGERS

TRIGGER commands associated with the channel slider (**fader**) and/or **ON/START** button press.

It can decide the command to be sent to the Remote **APP / Device** (for example, your Automation Software).

- at the slider **rise-up** or at the ON/START (**ON mode**) pressure (MACRO ON).
- at the slider **rise-down** or ON/START (**OFF mode**) pressure (MACRO OFF).

To learn more about this function, please consult the related ONAIR TRIGGERS chapter of this **OXYGEN REMOTER** User Manual.

<https://www.axeltechnology.com/public/oxygen3000d/man-oxygen%20remoter-en.pdf>

4.4. SERVICE



4.4.1. CONFIGURATION

One of the characteristics of OXYGEN is that all settings can be saved on an external memory stick and can be called again when needed, and the settings can also be exported from one mixer to another.

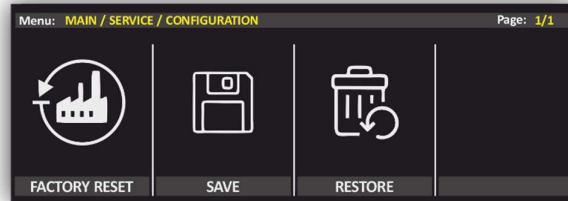

Factory reset

is a software restoration of the mixer to its original system state by erasing all of the information stored on the mixer. The factory reset is used to restore the device to its original manufacturer settings. Doing so will effectively erase all of the data, and settings that were previously on the device. This is often done to fix an issue with a device, but it could also be done to restore the device to its original settings.

The mixer will ask the confirmation if you select the factory reset to be sure that you like to delete all settings to go back to the original manufacturer settings.

SAVE

To save the configurations, the mixer will ask if you like to save them in the internal memory **SD** or export them to the external memory stick.

RESTORE

Restore the previously saved system state. when you enter this section, you find all of the saved configurations divided according to the date and time.

When you save the system state of the console, you are essentially saving a snapshot of all the settings, configurations, and files at a particular point in time. This can be useful in case something goes wrong with the system or if you want to revert back to a previous state for any reason.

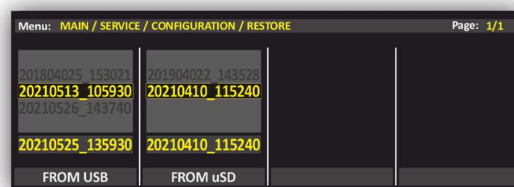

This can be helpful if you've made changes to your system that you want to undo, or if you're experiencing issues that you believe were caused by recent changes.

When you enter the section to restore the system state, you will typically see a list of all the saved configurations that are available to restore. These configurations are typically organized by date and time, so you can easily identify which one you want to use.

4.4.2. SOFTWARE



UPGRADE

MIXER FIRMWARE UPGRADE

must connect the OXYGEN to the internet. To do this using the **DHCP** or static IP address, go to:

MENU / GENERAL SET. / COMMUNICATIONS / TCP-IP / ADDRESS-1 or 2 / DHCP [\[MORE INFO\]](#)

Active it by selecting **(ON)** or setting the static IP that is given by your **IT MAN**. then go to

MENU / SERVICE / SOFTWARE / UPGRADE

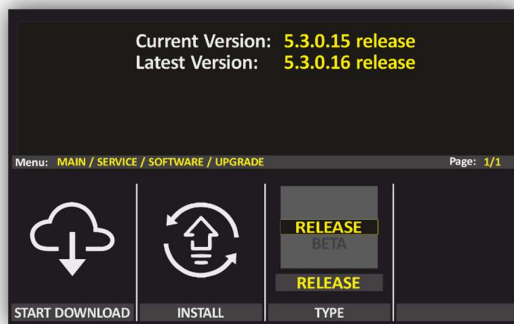

START DOWNLOAD: By pushing the knob of it, will start downloading the latest version available on the internet and it will show up the percentage of the processing.

INSTAL: When the download of the new version is done will see the message *“Upgrade is ready, install when ready”*. at this point, the icon of install will show in white color to indicate that is active, then you can push the knob to start installing the new version.

TYPE: By switching between RELEASE and BETA can know the **latest version** available and in the upper part of the display show up the number of the version.

UPGRADING PROCEDURE

1. Press the first knob (**start download**) to download the latest version.
2. When it is finished downloading, just click on the **INSTALL** knob to start the updating process.

ATTENTION:

- You have to wait until the system will finish the Upgrade. The system requires more or less than 6 minutes. **DO NOT PROCEED WHEN THE MIXER IS ON-AIR.**
- At the end of the upgrade, the system will ask to REBOOT from the power switch. **Oxygen** firmware is upgraded.
- If the process is not completed correctly and the OXYGEN is not ready for operation, you should contact the customer support department of **AXEL TECHNOLOGY**.

VERSION



FIRMWARE

From the following section, you can read the parameters related to the firmware version.

4.4.3. LOGS

the log file is a file that records events that occur in an operating system or other software runs. It is possible to access the **LOG** file from here and save it to the **USB memory**. it is also accessible from the **REMOTER** software and the console **WEB interface**.

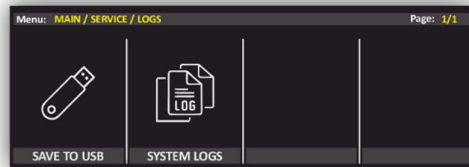

4.4.4. WEB LOGIN

From this part of the menu can set a new password for the web interface. The default **WEB** interface password is **root**. By rotating and pushing the knobs you can change the password of the **WEB login**. to cancel a character, scroll down and use <<.

4.4.5. DIAGNOSTIC

Diagnostic logs in OXYGEN digital audio mixer can provide valuable information to sound engineers and technicians about the performance of the mixer and any issues that may be affecting the sound quality or functionality of the device.

Some examples of the types of information that may be logged in a digital audio mixer's diagnostic logs include:

- **Error messages:** If the mixer encounters an error or issue, it may log an error message detailing the problem and any relevant information.
- **Performance metrics:** The mixer may log information about its performance, such as **CPU usage**, memory usage, and latency.
- **System events:** The mixer may log system events such as power **on/off**, software updates, and firmware upgrades.

By analyzing the diagnostic logs, sound engineers and technicians can identify any issues or anomalies that may be affecting the performance of the mixer and take appropriate action to address them. This can help to ensure that the audio being produced is of the highest quality and free from any technical issues.

4.4.6. SURFACE LOCK

This refers to a mode of operation in OXYGEN digital audio mixers where the surface of the mixer is locked, preventing any accidental or unauthorized changes to the mix settings.

When the Surface Lock mode is enabled, the physical controls on the mixer's surface, such as **faders**, **knobs**, and **buttons**, are disabled, and the user cannot make any adjustments to the mix. This feature is useful in live sound situations where multiple engineers or performers may be working on the same mixer, and it is important to prevent accidental changes to the mix.

To make changes to the mix settings, the user must first disable the Surface Lock mode,

PRESS, AND HOLD THE 4 KNOBS OFF THE MENU TOGETHER FOR 5 SECONDS.



This ensures that only authorized personnel can make changes to the mix, improving the overall quality and consistency of the sound.

4.4.7. KICK REMOTE CLIENT

From here may disconnect the audio engineer by terminating their remote session or revoking their access privileges. To can disconnect the client who controls the audio mixer remotely from the **REMOTER** (software interface).

+ 187-RJ45-MIC

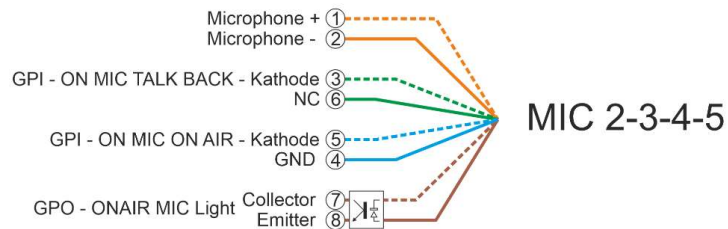
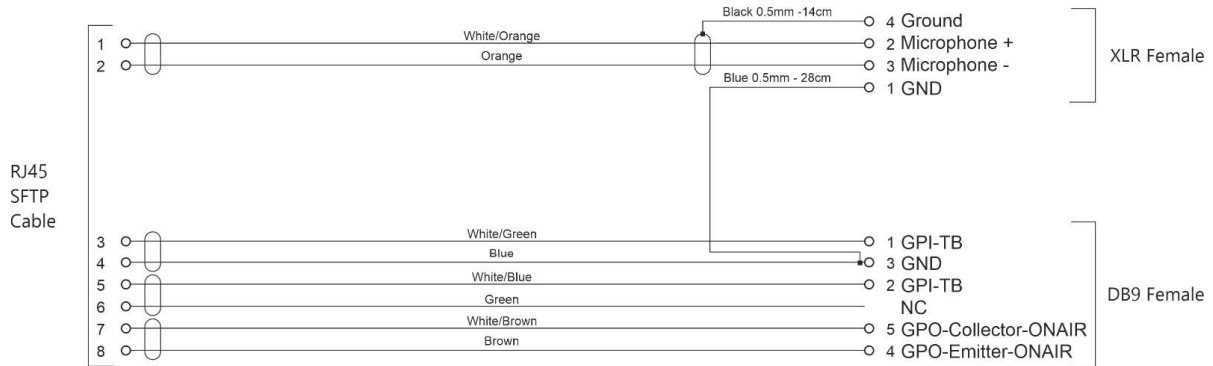
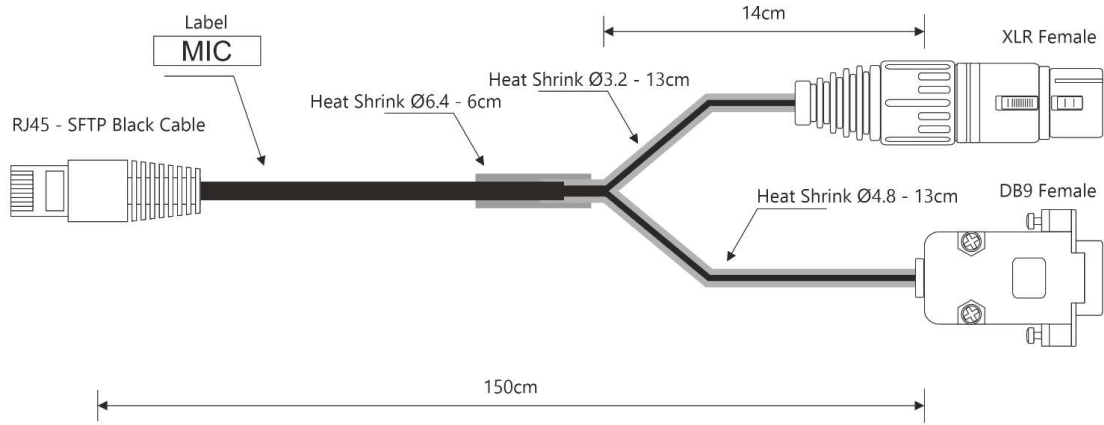

+ 188-RJ45-TELCO

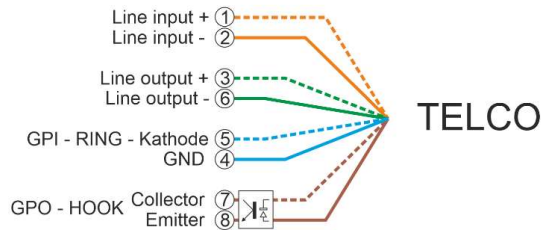
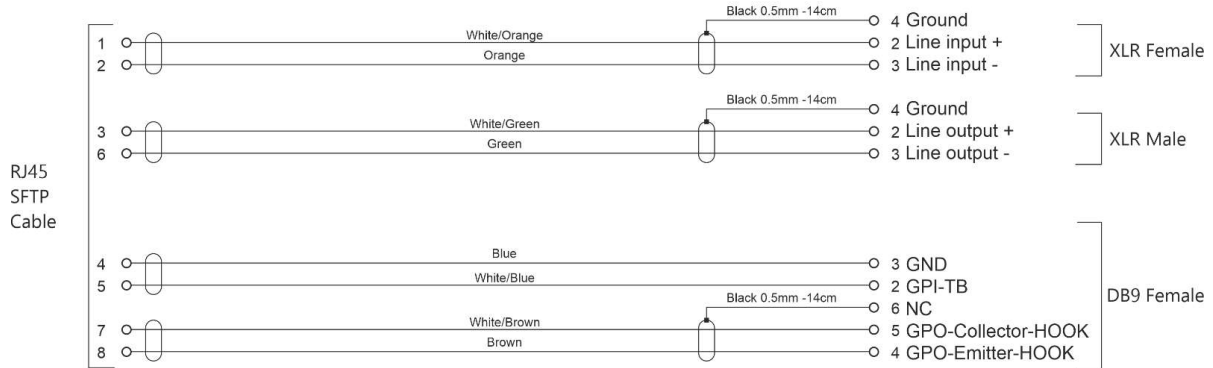
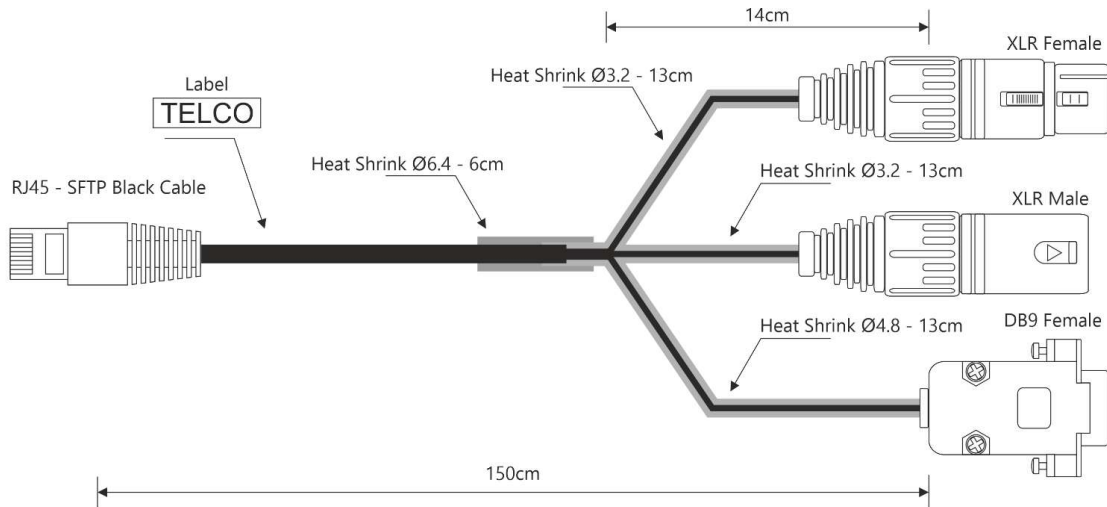

+ 189-RJ45-LINE-IN

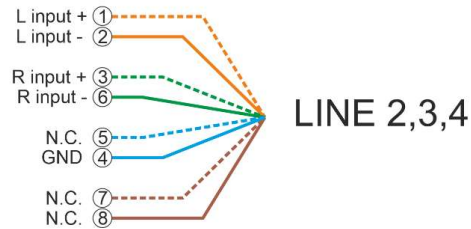
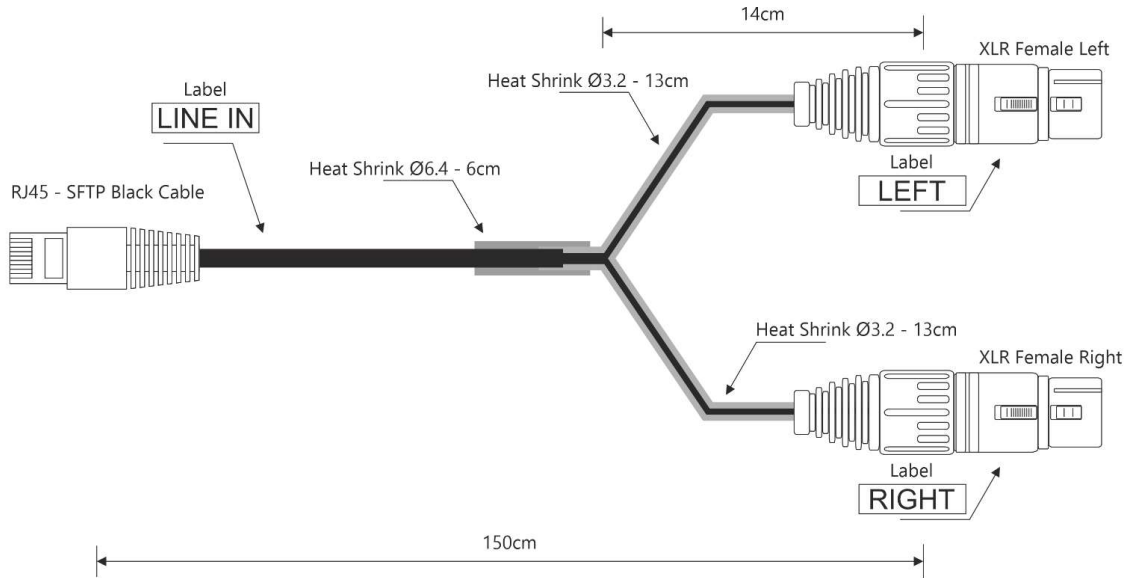

+ 190-RJ45-LINE-OUT

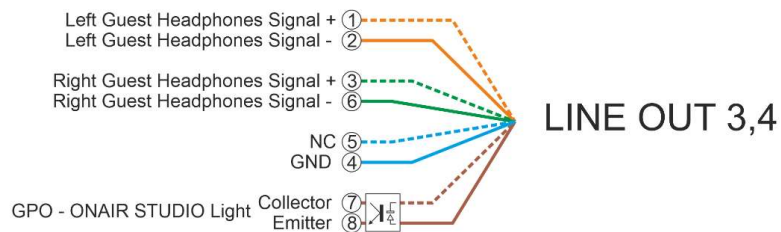
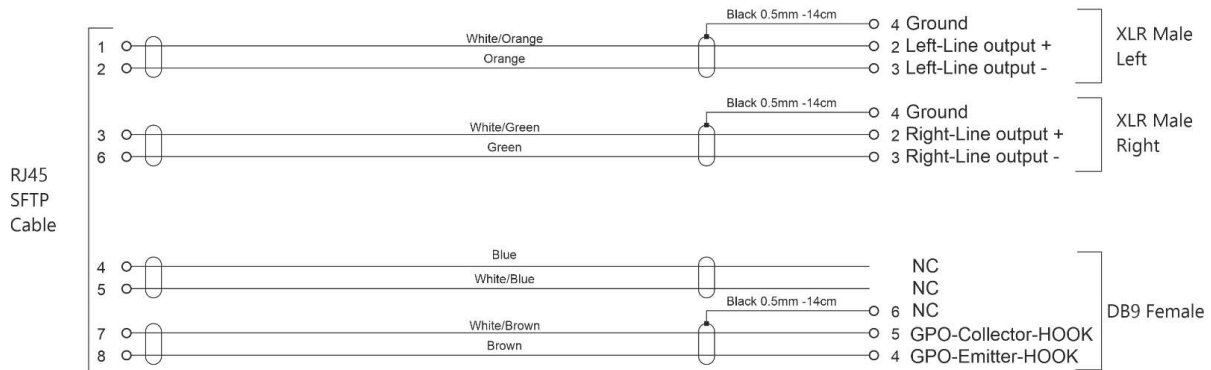
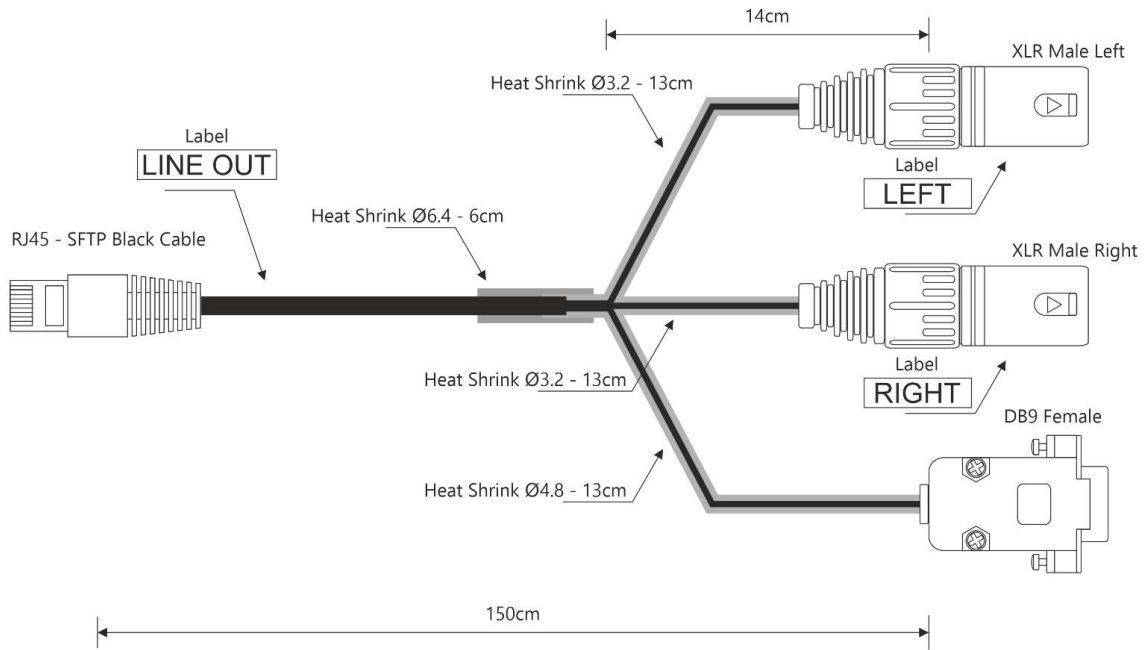

TECH SPECS

Analog Balanced Microphone Inputs

Connector RJ45 & XLR Balanced – EMI Suppressed

Input Impedance 2,4 K Ω

Nominal Input Level (sensitivity) -9/-66 dBu

Max Input Level (clipping point) +9 dBu

A/D conversion 24-bit / 48 kHz

Signal To Noise Ratio (referred as peak level) >110 dB

THD+N <0,01%

Analog Gain Adjustable +0 ÷ +60 dB (3dB step)

Phantom Power +48V

Analog Balanced Stereo Inputs

Connector XLR & RJ45 Balanced – EMI Suppressed

Input Impedance 10 K Ω

Nominal Input Level (sensitivity) 0 dBu

Max Input Level (clipping point) +18 dBu

A/D conversion 24-bit / 48 kHz

Frequency response +/-0,5 dB from 20 Hz to 20 kHz

Signal To Noise Ratio (referred to as peak level) >100 dB

Stereo Separation (referred to as peak level) >90 dB

THD+N <0,002 %

Analog Balanced Telco Input

Connector RJ45 Balanced – EMI Suppressed

Input Impedance 10 K Ω

Nominal Input Level (sensitivity) 0 dBu

Max Input Level (clipping point) +18 dBu

A/D conversion 24-bit / 48 kHz

Signal To Noise Ratio (referred to as peak level) >110 dB

THD+N <0,002%

Digital Input

| | |
|----------------------------------|------------------------------------|
| Connector | Balanced on 1 XLR – EMI Suppressed |
| Input Impedance | 110 K Ω |
| Standard | AES3 |
| Audio Sample Rate | 32/44.1/48/96/192 KHz with SRC |
| Resolution | 24 bit |
| Dynamic Range (Converter Values) | 124 dB |

Analog Balanced Stereo Outputs

| | |
|--|------------------------------------|
| Connector | RJ45 Balanced – EMI Suppressed |
| Output Impedance | 23 Ω , nominal 600 Ω |
| Nominal Output Level | 0 dBu |
| Max Output Level (clipping point) | +18 dBu |
| D/A conversion | 24 bit / 48 KHz |
| Signal To Noise Ratio (referred to peak level) | >110 dB |
| Stereo Separation (referred to peak level) | >90 dB |
| THD+N | <0,002 % |

Dante I/O

| | |
|-------------------------|--|
| Audio Buffering | Up to 2000 samples per channel |
| Audio Flows In/Out | Up to 32x32 simultaneous streams |
| Audio Transport Formats | Dante Audio over IP, AES67 RTP, SMPTE ST2110-30 RTP (enrolled devices) |
| Clock | High quality, low jitter onboard SiLabs |
| Clocking | Onboard word clock or external word clock |
| Control Interfaces | SPI Master and Slave; GPIO; I2C |
| Digital Audio Formats | TDM, I2S |
| Ethernet | Standard RGMII/MII interface for Ethernet PHY or switch chip |
| Form Factor | Card edge module. 4.5cm x 6cm (1.75" x 2.4") |
| FPGA | High performance Xilinx Spartan6 FPGA |
| Microprocessor | Soft-core Microblaze processor |
| Network | RGMII/MII |

Dante I/O

Physical Connector Mini-PCI

Power 3.3VDC @ 2W max

Sample Bit Depth 16, 24 or 32 bits per sample

Sample Rates (16x16 Versions) 44.1/48/88.2/96 kHz

Sample Rates (32x32 Versions) 44.1/48/88.2/96 kHz

USB Audio Digital I/O

Connector USB Type B – EMI Suppressed

Playback And Recording Sample Rate SRC 44.1-48 KHz

Resolution 16 bit

Available Stereo Channels 2 stereo USB - 2 Inputs/Output on each Audio Board

Analog Balanced Talkbox Outputs

Connector RJ45 balanced – EMI Suppressed

Output Impedance 100ohm, nominal 600ohm

Nominal Output Level 0dBu

Max Output Level (clipping point) +14dBu

D/A conversion 24 bit / 48 Khz

Signal To Noise Ratio (referred to peak level) >110dB

Stereo Separation (referred to peak level) >90dB

THD+N <0,05%

Analog Balanced Telco Output

Connector RJ45 Balanced – EMI Suppressed

Output Impedance 23 Ω , nominal 600 Ω

Nominal Output Level 0 dBu

Max Output Level (clipping point) +18 dBu

D/A conversion 24 bit / 48 Khz

Signal To Noise Ratio (referred to peak level) >110 dB

THD+N <0,002 %

Digital Output

Connector **Balanced on 1 XLR – EMI Suppressed**

Input Impedance **110 Ω**

Standard **AES3**

Audio Sample Rate **32/44.1/48/96/192 KHz**

Resolution **24 bit**

Dynamic Range (Converter Values) **124 dB**

PSTN Interface

Connector **RJ11**

Transhybrid loss **>20 dB**

System

Audio Core **Analog Devices ADAU1452 32bit 294 MHz fixed point DSP**

Audio CODECs **Cirrus CS42448 24 bit/192 kHz**

LAN Connection **RJ45 - 1 Gbit**

Nominal Delay (analog input to analog output) **0,7 ms**

GPIO Inputs/Outputs **4 GPIO on DB9; 4 GPI/2 GPO on Mic2 & Mic3 RJ45; 2 GPO on Out3 & Out4 RJ45; 1 GPI/1 GPO on Telco RJ45**

Communication Port **2xUSB type-A, 2xUSB type-B , 1xLAN, 1xHDMI**

Operating Temperature **0°C ÷ 40°C**

Dimensions

8 Faders Dimensions (W; H; D) **584 mm; 113,5 mm; 495,5 mm**

12 Faders Dimensions (W; H; D) **764 mm; 113,5 mm; 495,5 mm**

16 Faders Dimensions (W; H; D) **944 mm; 113,5 mm; 495,5 mm**

Weight **15 to 25 Kg**

PSU

Type **External Universal Switching Power Supply 12V with 4 poles XLR connections - Optional Redundant**

Power Supply **90-264 VAC / 50-60 Hz / 120 W**

WEEE DIRECTIVE – INFORMATIVA RAEE



In line with EU Directive 2002/96/EC for waste electrical and electronic equipment (WEEE), this electrical product must not be disposed of as unsorted municipal waste. Please dispose of this product by returning it to the point of sale or to your local municipal collection point for recycling.

In Übereinstimmung mit der Richtlinie 2002/96/EG des Europäischen Parlaments

und des Rates über Elektro- und Elektronik-Altgeräte (WEEE) darf dieses Elektrogerät nicht im normalen Hausmüll oder dem Gelben Sack entsorgt werden. Wenn Sie dieses Produkt entsorgen möchten, bringen Sie es bitte zur Verkaufsstelle zurück oder zum Recycling-Sammelpunkt Ihrer Gemeinde.

Conformément à la Directive 2002/96/EC sur les déchets d'équipements électriques et électroniques (DEEE), ce produit électrique ne doit en aucun cas être mis au rebut sous forme de déchet municipal non trié. Veuillez vous débarrasser de ce produit en le renvoyant à son point de vente ou au point de ramassage local dans votre municipalité, à des fins de recyclage.

In navolging van richtlijn 2002/96/EG van het Europees Parlement en de Raad betreffende afgedankte elektrische en elektronische apparatuur (AEEA) mag dit elektrische product niet als ongescheiden huisvuil worden weggedaan. Breng dit product terug naar de plaats van aankoop of naar het gemeentelijke afvalinzamelingspunt voor recycling.

In ottemperanza alla Direttiva UE 2002/96/EC sui rifiuti di apparecchiature elettriche ed elettroniche (RAEE), questo prodotto elettrico non deve essere smaltito come rifiuto municipale misto. Si prega di smaltire il prodotto riportandolo al punto vendita o al punto di raccolta municipale locale per un opportuno riciclaggio.

De conformidad con la Directiva 2002/96/CE de la UE sobre residuos de aparatos eléctricos y electrónicos (RAEE), este producto eléctrico no puede desecharse con el resto de residuos no clasificados. Deshágase de este producto devolviéndolo al punto de venta o a un punto de recogida municipal para su reciclaje.

I henhold til EU-direktiv 2002/96/EF om affald af elektrisk og elektronisk udstyr (WEEE) må dette udstyr ikke bortskaffes som usorteret husholdningsaffald. Bortskaf dette produkt ved at returnere det til salgsstedet eller til det lokale indsamlingssted, så det kan genbruges.

I linje med EU-direktiv 2002/96/EG om avfall som utgörs av eller innehåller elektriska eller elektroniska produkter (WEEE) får denna elektriska produkt inte bortskaffas som osorterat kommunalt avfall. Bortskaffa den i stället genom att lämna in den på försäljningsstället eller din lokala återvinningsstation.

EU:n sähkö- ja elektroniikkalaiteromudirektiivin (2002/96/EY) mukaisesti tätä elektroniikkalaitetta ei saa laittaa lajittelemattoman yhdyskuntajätteen sekaan. Hävitä laite palauttamalla se ostopaikkaan tai viemällä se elektroniikkaromun keräyspisteeseen.

De acordo com a Directiva Europeia 2002/96/EC sobre resíduos sólidos de equipamento eléctrico e electrónico (WEEE), este produto eléctrico não pode ser deixado fora juntamente com o lixo municipal indiferenciado. Por favor, no final da vida útil deste produto, devolva-o ao estabelecimento de aquisição, ou entregue no local de recolha apropriado para reciclagem designado pelo seu município.

V souladu se smrnici EU . 2002/96/ES o odpadních elektrických a elektronických zaYizeních (OEEZ) se tento elektrický výrobek nesmí likvidovat jako netYidný komunální odpad. PYí likvidaento výrobek vra'te prodejci nebo ho odevzdejte k recyklaci do komunálního sbrného zaYizení.

Vastavalt EL direktiivile 2002/96/EÜ, mis käsitleb elektri- ja elektroonikaseadmete jäätmeid (WEEE), ei või antud toodet visata majapidamisjäätmete hulka. Palun tagastage antud toode taaskasutamise eesmärgil müügipunkti või kohaliku piirkonna jäätmekogumise punkti.

V súlade so smernicou 2002/96/ES o odpade z elektrických a elektronických zariadení (OEEZ) sa toto elektrické zariadenie nesmie odstranovať ako netriedený komunálny odpad. Výrobok odstráňte jeho vrátením v mieste nákupu alebo odovzdaním v miestnom zbernom zariadení na recyklovanie.

V súlade so smernicou 2002/96/ES o odpade z elektrických a elektronických zariadení (OEEZ) sa toto elektrické zariadenie nesmie odstranovať ako netriedený komunálny odpad. Výrobok odstráňte jeho vrátením v mieste nákupu alebo odovzdaním v miestnom zbernom zariadení na recyklovanie.

WARRANTY

The manufacturer offers a one-year warranty ex-works. Do not open the equipment. Any breaking of the seals will result in the forfeiture of the same. The manufacturer is not liable for damages of any kind arising from, or in connection with, the use of the wrong product.



Dichiarazione di conformità

| | |
|---|---|
| Il sottoscritto Giuseppe Vaccari | |
| In qualità di legale rappresentante della società Axel Technology S.r.l. | |
| con sede in: Via Caduti di Sabbiuno, 6/F – 40011 – Anzola Emilia (BO) | |
| Partita IVA: IT01735031203 | |
| Dichiara | |
| che il prodotto: Digital broadcast console 8 Faders; 5 Mic IN with +48v; 3 bal. stereo IN; 2 USB Audio I/O; 1 Telephone Hybrid; 1 Bluetooth I/O; 1 Telco Audio; GPIO; 4 bal. stereo Out; 1 Digital I/O; 1 Headphones; Streaming I/O. 7" Display. HDMI out. Remote control software. | |
| Modello e/o codice: OXYGEN 3000 PLUS 8F-1AIO-Dante Option | |
| Data Fabbricazione: vedi etichetta sul prodotto | Numero di serie: vedi etichetta sul prodotto |
| È stato costruito rispettando le seguenti direttive e norme: | |
| <ul style="list-style-type: none"> • Direttiva 2014/53/UE nota come "Direttiva RED" • Direttiva 2014/35/UE nota come "Direttiva bassa tensione" • Direttiva 2014/30/UE nota come "Direttiva compatibilità elettromagnetica" • Direttiva 2011/65/CE nota come "RoHS" • Direttiva delegata (UE) 2015/863 della commissione del 31 marzo 2015 recante modifica dell'allegato II della direttiva 2011/65/UE • Direttiva 2012/19/UE nota come "RAEE" • Direttiva 2001/95/CE nota "Sicurezza generale dei prodotti" • UNI EN ISO 7010:2021 Titolo: Segni grafici - Colori e segnali di sicurezza - Segnali di sicurezza registrati • EN 62368-1:2018 - relativa alla sicurezza elettrica per le apparecchiature informatiche e i prodotti audio/video • IEC 62311:2019 - Valutazione degli apparecchi elettronici ed elettrici in relazione alle restrizioni per l'esposizione umana ai campi elettromagnetici (0 Hz – 300 GHz) • EN 301 489-1 V2.2.3 (2019-11) - Standard di compatibilità elettromagnetica (EMC) per apparecchiature e servizi radio; Parte 1: requisiti tecnici comuni; Norma armonizzata per la compatibilità elettromagnetica • EN 301 489-17 V3.2.4 (2020-09) - Standard di compatibilità elettromagnetica (EMC) per apparecchiature e servizi radio Parte 17: Condizioni specifiche per sistemi di trasmissione dati a banda larga; Norma armonizzata per la compatibilità elettromagnetica • EN 300 328 V2.2.2 (2019-07) Sistemi di trasmissione a banda larga; apparecchiature di trasmissione dati operanti nella banda 2,4 GHz; Norma armonizzata per l'accesso allo spettro radio • EN 55032:2015+A1:2020 - Compatibilità elettromagnetica delle apparecchiature multimediali. Requisiti di emissione • EN 55103-2:2010 Norme di famiglie di prodotto per apparecchi audio, video, audiovisivi e di comando di luci da intrattenimento per uso professionale - Parte 2: Immunità. • EN 60065:2019 Apparecchi audio, video e apparecchi elettronici similari Requisiti di sicurezza. • EN 61000-6-1:2016 – EMC – Immunità per ambienti residenziali, commerciali e industria leggera. • EN 61000-6-3:2020 – EMC – Emissione per ambienti residenziali, commerciali e industria leggera. • EN 60950-1:2014 – Sicurezza degli apparati ITE (Information Technology Equipment) • EN 55024:2017 Apparecchiature per la tecnologia dell'informazione - Caratteristiche di immunità Limiti e metodi di misura. • EN IEC 63000:2018 Nuovo standard armonizzato per dimostrare la conformità RoHS • EN 55032:2015+A11:2020 Compatibilità elettromagnetica delle apparecchiature multimediali - Requisiti di emissione • EN 55035:2017 - Compatibilità elettromagnetica delle apparecchiature multimediali - Requisiti di immunità | |
| Ed è quindi conforme alle direttive e normative vigenti. | |
| La presente dichiarazione di conformità è rilasciata sotto la responsabilità esclusiva del fabbricante. | |
| Data: 18/09/2023 | Firma:  |
| Luogo: ANZOLA DELL'EMILIA (BO) - ITALIA | |



Dichiarazione di conformità

| | |
|---|---|
| Il sottoscritto Giuseppe Vaccari | |
| In qualità di legale rappresentante della società Axel Technology S.r.l. | |
| con sede in: Via Caduti di Sabbiuno, 6/F – 40011 – Anzola Emilia (BO) | |
| Partita IVA: IT01735031203 | |
| Dichiara | |
| che il prodotto: Digital broadcast console 12 Faders; 10 Mic IN with +48v; 6 bal. stereo IN; 4 USB Audio I/O; 2 Telephone Hybrid; 2 Bluetooth I/O; 2 Telco Audio; GPIO; 8 bal. stereo Out; 2 Digital I/O; 2 Headphones; Streaming I/O. 7" Display. HDMI out. Remote control software. | |
| Modello e/o codice: OXYGEN 3000 PLUS 12F-2AIO-Dante Option | |
| Data Fabbricazione: vedi etichetta sul prodotto | Numero di serie: vedi etichetta sul prodotto |
| È stato costruito rispettando le seguenti direttive e norme: | |
| <ul style="list-style-type: none"> • Direttiva 2014/53/UE nota come "Direttiva RED" • Direttiva 2014/35/UE nota come "Direttiva bassa tensione" • Direttiva 2014/30/UE nota come "Direttiva compatibilità elettromagnetica" • Direttiva 2011/65/CE nota come "RoHS" • Direttiva delegata (UE) 2015/863 della commissione del 31 marzo 2015 recante modifica dell'allegato II della direttiva 2011/65/UE • Direttiva 2012/19/UE nota come "RAEE" • Direttiva 2001/95/CE nota "Sicurezza generale dei prodotti" • UNI EN ISO 7010:2021 Titolo: Segni grafici - Colori e segnali di sicurezza - Segnali di sicurezza registrati • EN 62368-1:2018 - relativa alla sicurezza elettrica per le apparecchiature informatiche e i prodotti audio/video • IEC 62311:2019 - Valutazione degli apparecchi elettronici ed elettrici in relazione alle restrizioni per l'esposizione umana ai campi elettromagnetici (0 Hz – 300 GHz) • EN 301 489-1 V2.2.3 (2019-11) - Standard di compatibilità elettromagnetica (EMC) per apparecchiature e servizi radio; Parte 1: requisiti tecnici comuni; Norma armonizzata per la compatibilità elettromagnetica • EN 301 489-17 V3.2.4 (2020-09) - Standard di compatibilità elettromagnetica (EMC) per apparecchiature e servizi radio Parte 17: Condizioni specifiche per sistemi di trasmissione dati a banda larga; Norma armonizzata per la compatibilità elettromagnetica • EN 300 328 V2.2.2 (2019-07) Sistemi di trasmissione a banda larga; apparecchiature di trasmissione dati operanti nella banda 2,4 GHz; Norma armonizzata per l'accesso allo spettro radio • EN 55032:2015+A1:2020 - Compatibilità elettromagnetica delle apparecchiature multimediali. Requisiti di emissione • EN 55103-2:2010 Norme di famiglie di prodotto per apparecchi audio, video, audiovisivi e di comando di luci da intrattenimento per uso professionale - Parte 2: Immunità. • EN 60065:2019 Apparecchi audio, video e apparecchi elettronici similari Requisiti di sicurezza. • EN 61000-6-1:2016 – EMC – Immunità per ambienti residenziali, commerciali e industria leggera. • EN 61000-6-3:2020 – EMC – Emissione per ambienti residenziali, commerciali e industria leggera. • EN 60950-1:2014 – Sicurezza degli apparati ITE (Information Technology Equipment) • EN 55024:2017 Apparecchiature per la tecnologia dell'informazione - Caratteristiche di immunità Limiti e metodi di misura. • EN IEC 63000:2018 Nuovo standard armonizzato per dimostrare la conformità RoHS • EN 55032:2015+A11:2020 Compatibilità elettromagnetica delle apparecchiature multimediali - Requisiti di emissione • EN 55035:2017 - Compatibilità elettromagnetica delle apparecchiature multimediali - Requisiti di immunità | |
| Ed è quindi conforme alle direttive e normative vigenti. | |
| La presente dichiarazione di conformità è rilasciata sotto la responsabilità esclusiva del fabbricante. | |
| Data: 18/09/2023 | Firma:  |
| Luogo: ANZOLA DELL'EMILIA (BO) - ITALIA | |



Dichiarazione di conformità

| | |
|---|---|
| Il sottoscritto Giuseppe Vaccari | |
| In qualità di legale rappresentante della società Axel Technology S.r.l. | |
| con sede in: Via Caduti di Sabbiuno, 6/F – 40011 – Anzola Emilia (BO) | |
| Partita IVA: IT01735031203 | |
| Dichiara | |
| che il prodotto: Digital broadcast console 16 Faders; 10 Mic IN with +48v; 6 bal. stereo IN; 4 USB Audio I/O; 2 Telephone Hybrid; 2 Bluetooth I/O; 2 Telco Audio; GPIO; 8 bal. stereo Out; 2 Digital I/O; 2 Headphones; Streaming I/O. 7" Display. HDMI out. Remote control software. | |
| Modello e/o codice: OXYGEN 3000 PLUS 16F-2AIO-Dante Option | |
| Data Fabbricazione: vedi etichetta sul prodotto | Numero di serie: vedi etichetta sul prodotto |
| È stato costruito rispettando le seguenti direttive e norme: | |
| <ul style="list-style-type: none"> • Direttiva 2014/53/UE nota come "Direttiva RED" • Direttiva 2014/35/UE nota come "Direttiva bassa tensione" • Direttiva 2014/30/UE nota come "Direttiva compatibilità elettromagnetica" • Direttiva 2011/65/CE nota come "RoHS" • Direttiva delegata (UE) 2015/863 della commissione del 31 marzo 2015 recante modifica dell'allegato II della direttiva 2011/65/UE • Direttiva 2012/19/UE nota come "RAEE" • Direttiva 2001/95/CE nota "Sicurezza generale dei prodotti" • UNI EN ISO 7010:2021 Titolo: Segni grafici - Colori e segnali di sicurezza - Segnali di sicurezza registrati • EN 62368-1:2018 - relativa alla sicurezza elettrica per le apparecchiature informatiche e i prodotti audio/video • IEC 62311:2019 - Valutazione degli apparecchi elettronici ed elettrici in relazione alle restrizioni per l'esposizione umana ai campi elettromagnetici (0 Hz – 300 GHz) • EN 301 489-1 V2.2.3 (2019-11) - Standard di compatibilità elettromagnetica (EMC) per apparecchiature e servizi radio; Parte 1: requisiti tecnici comuni; Norma armonizzata per la compatibilità elettromagnetica • EN 301 489-17 V3.2.4 (2020-09) - Standard di compatibilità elettromagnetica (EMC) per apparecchiature e servizi radio Parte 17: Condizioni specifiche per sistemi di trasmissione dati a banda larga; Norma armonizzata per la compatibilità elettromagnetica • EN 300 328 V2.2.2 (2019-07) Sistemi di trasmissione a banda larga; apparecchiature di trasmissione dati operanti nella banda 2,4 GHz; Norma armonizzata per l'accesso allo spettro radio • EN 55032:2015+A1:2020 - Compatibilità elettromagnetica delle apparecchiature multimediali. Requisiti di emissione • EN 55103-2:2010 Norme di famiglie di prodotto per apparecchi audio, video, audiovisivi e di comando di luci da intrattenimento per uso professionale - Parte 2: Immunità. • EN 60065:2019 Apparecchi audio, video e apparecchi elettronici similari Requisiti di sicurezza. • EN 61000-6-1:2016 – EMC – Immunità per ambienti residenziali, commerciali e industria leggera. • EN 61000-6-3:2020 – EMC – Emissione per ambienti residenziali, commerciali e industria leggera. • EN 60950-1:2014 – Sicurezza degli apparati ITE (Information Technology Equipment) • EN 55024:2017 Apparecchiature per la tecnologia dell'informazione - Caratteristiche di immunità Limiti e metodi di misura. • EN IEC 63000:2018 Nuovo standard armonizzato per dimostrare la conformità RoHS • EN 55032:2015+A11:2020 Compatibilità elettromagnetica delle apparecchiature multimediali - Requisiti di emissione • EN 55035:2017 - Compatibilità elettromagnetica delle apparecchiature multimediali - Requisiti di immunità | |
| Ed è quindi conforme alle direttive e normative vigenti. | |
| La presente dichiarazione di conformità è rilasciata sotto la responsabilità esclusiva del fabbricante. | |
| Data: 18/09/2023 | Firma:  |
| Luogo: ANZOLA DELL'EMILIA (BO) - ITALIA | |

CE Declaration of Conformity

| | |
|---|---|
| The undersigned Giuseppe Vaccari | |
| As legal representative of the company Axel Technology Srl | |
| based in: Via Caduti di Sabbiuono, 6/F – 40011 – Anzola Emilia (BO) | |
| VAT number: IT01735031203 | |
| <i>declares</i> | |
| that the product: Digital broadcast console 8 Faders; 5 Mic IN with +48v; 3 bal. stereo IN; 2 USB Audio I/O; 1 Telephone Hybrid; 1 Bluetooth I/O; 1 Telco Audio; GPIO; 4 bal. stereo Out; 1 Digital I/O; 1 Headphones; Streaming I/O. 7" Display. HDMI out. Remote control software. | |
| Model and/or code: OXYGEN 3000 PLUS 8F-1AIO-Dante Option | |
| Date of manufacture: see label on the product | Serial number: see label on the product |
| It was built in compliance with the following directives and standards: | |
| <ul style="list-style-type: none"> • Directive 2014/53/EU known as the "RED Directive" • Directive 2014/35/EU known as the "Low Voltage Directive" • Directive 2014/30/EU known as the "Electromagnetic Compatibility Directive" • Directive 2011/65/EC known as "RoHS" • Commission Delegated Directive (EU) 2015/863 of 31 March 2015 amending Annex II of Directive 2011/65/EU • Directive 2012/19/EU known as "WEEE" • Directive 2001/95/EC known as "General product safety" • UNI EN ISO 7010:2021 Title: Graphic signs - Colors and safety signs - Registered safety signs • EN 62368-1:2018 - relating to electrical safety for computer equipment and audio/video products • IEC 62311:2019 - Evaluation of electronic and electrical equipment with regard to restrictions on human exposure to electromagnetic fields (0 Hz – 300 GHz) • EN 301 489-1 V2.2.3 (2019-11) - Electromagnetic compatibility (EMC) standard for radio equipment and services; Part 1: common technical requirements; Harmonized standard for electromagnetic compatibility • EN 301 489-17 V3.2.4 (2020-09) - Electromagnetic compatibility (EMC) standard for radio equipment and services Part 17: Specific conditions for broadband data transmission systems; Harmonized standard for electromagnetic compatibility • EN 300 328 V2.2.2 (2019-07) Broadband transmission systems; data transmission equipment operating in the 2.4 GHz band; Harmonized standard for access to the radio spectrum • EN 55032:2015+A1:2020 - Electromagnetic compatibility of multimedia equipment. Issue requirements • EN 55103-2:2010 Product family standard for audio, video, audio-visual and entertainment lighting control apparatus for professional use - Part 2: Immunity. • EN 60065:2019 Audio, video and similar electronic equipment Safety requirements. • EN 61000-6-1:2016 – EMC – Immunity for residential, commercial and light industry environments. • EN 61000-6-3:2020 – EMC – Emission for residential, commercial and light industry environments. • EN 60950-1:2014 – Safety of ITE (Information Technology Equipment) • EN 55024:2017 Information technology equipment - Immunity characteristics Limits and methods of measurement. • EN IEC 63000:2018 New harmonized standard to demonstrate RoHS compliance • EN 55032:2015+A11:2020 Electromagnetic compatibility of multimedia equipment - Emission requirements • EN 55035:2017 - Electromagnetic compatibility of multimedia equipment - Immunity requirements | |
| And it is therefore compliant with current directives and regulations. | |
| This declaration of conformity is issued under the sole responsibility of the manufacturer. | |
| Date: 18/09/2023 | Signature:  |
| Place: ANZOLA DELL'EMILIA (BO) - ITALY | |

CE Declaration of Conformity

| | |
|---|---|
| The undersigned Giuseppe Vaccari | |
| As legal representative of the company Axel Technology Srl | |
| based in: Via Caduti di Sabbiuno, 6/F – 40011 – Anzola Emilia (BO) | |
| VAT number: IT01735031203 | |
| <i>declares</i> | |
| that the product: Digital broadcast console 12 Faders; 10 Mic IN with +48v; 6 bal. stereo IN; 4 USB Audio I/O; 2 Telephone Hybrid; 2 Bluetooth I/O; 2 Telco Audio; GPIO; 8 bal. stereo Out; 2 Digital I/O; 2 Headphones; Streaming I/O. 7" Display. HDMI out. Remote control software. | |
| Model and/or code: OXYGEN 3000 PLUS 12F-2AIO-Dante Option | |
| Date of manufacture: see label on the product | Serial number: see label on the product |
| It was built in compliance with the following directives and standards: | |
| <ul style="list-style-type: none"> • Directive 2014/53/EU known as the "RED Directive" • Directive 2014/35/EU known as the "Low Voltage Directive" • Directive 2014/30/EU known as the "Electromagnetic Compatibility Directive" • Directive 2011/65/EC known as "RoHS" • Commission Delegated Directive (EU) 2015/863 of 31 March 2015 amending Annex II of Directive 2011/65/EU • Directive 2012/19/EU known as "WEEE" • Directive 2001/95/EC known as "General product safety" • UNI EN ISO 7010:2021 Title: Graphic signs - Colors and safety signs - Registered safety signs • EN 62368-1:2018 - relating to electrical safety for computer equipment and audio/video products • IEC 62311:2019 - Evaluation of electronic and electrical equipment with regard to restrictions on human exposure to electromagnetic fields (0 Hz – 300 GHz) • EN 301 489-1 V2.2.3 (2019-11) - Electromagnetic compatibility (EMC) standard for radio equipment and services; Part 1: common technical requirements; Harmonized standard for electromagnetic compatibility • EN 301 489-17 V3.2.4 (2020-09) - Electromagnetic compatibility (EMC) standard for radio equipment and services Part 17: Specific conditions for broadband data transmission systems; Harmonized standard for electromagnetic compatibility • EN 300 328 V2.2.2 (2019-07) Broadband transmission systems; data transmission equipment operating in the 2.4 GHz band; Harmonized standard for access to the radio spectrum • EN 55032:2015+A1:2020 - Electromagnetic compatibility of multimedia equipment. Issue requirements • EN 55103-2:2010 Product family standard for audio, video, audio-visual and entertainment lighting control apparatus for professional use - Part 2: Immunity. • EN 60065:2019 Audio, video and similar electronic equipment Safety requirements. • EN 61000-6-1:2016 – EMC – Immunity for residential, commercial and light industry environments. • EN 61000-6-3:2020 – EMC – Emission for residential, commercial and light industry environments. • EN 60950-1:2014 – Safety of ITE (Information Technology Equipment) • EN 55024:2017 Information technology equipment - Immunity characteristics Limits and methods of measurement. • EN IEC 63000:2018 New harmonized standard to demonstrate RoHS compliance • EN 55032:2015+A11:2020 Electromagnetic compatibility of multimedia equipment - Emission requirements • EN 55035:2017 - Electromagnetic compatibility of multimedia equipment - Immunity requirements | |
| And it is therefore compliant with current directives and regulations. | |
| This declaration of conformity is issued under the sole responsibility of the manufacturer. | |
| Date: 18/09/2023 | Signature:  |
| Place: ANZOLA DELL'EMILIA (BO) - ITALY | |

CE Declaration of Conformity

| | |
|---|---|
| The undersigned Giuseppe Vaccari | |
| As legal representative of the company Axel Technology Srl | |
| based in: Via Caduti di Sabbiuno, 6/F – 40011 – Anzola Emilia (BO) | |
| VAT number: IT01735031203 | |
| <i>declares</i> | |
| that the product: Digital broadcast console 16 Faders; 10 Mic IN with +48v; 6 bal. stereo IN; 4 USB Audio I/O; 2 Telephone Hybrid; 2 Bluetooth I/O; 2 Telco Audio; GPIO; 8 bal. stereo Out; 2 Digital I/O; 2 Headphones; Streaming I/O. 7" Display. HDMI out. Remote control software.. | |
| Model and/or code: OXYGEN 3000 PLUS 16F-2AIO-Dante Option | |
| Date of manufacture: see label on the product | Serial number: see label on the product |
| It was built in compliance with the following directives and standards: | |
| <ul style="list-style-type: none"> • Directive 2014/53/EU known as the "RED Directive" • Directive 2014/35/EU known as the "Low Voltage Directive" • Directive 2014/30/EU known as the "Electromagnetic Compatibility Directive" • Directive 2011/65/EC known as "RoHS" • Commission Delegated Directive (EU) 2015/863 of 31 March 2015 amending Annex II of Directive 2011/65/EU • Directive 2012/19/EU known as "WEEE" • Directive 2001/95/EC known as "General product safety" • UNI EN ISO 7010:2021 Title: Graphic signs - Colors and safety signs - Registered safety signs • EN 62368-1:2018 - relating to electrical safety for computer equipment and audio/video products • IEC 62311:2019 - Evaluation of electronic and electrical equipment with regard to restrictions on human exposure to electromagnetic fields (0 Hz – 300 GHz) • EN 301 489-1 V2.2.3 (2019-11) - Electromagnetic compatibility (EMC) standard for radio equipment and services; Part 1: common technical requirements; Harmonized standard for electromagnetic compatibility • EN 301 489-17 V3.2.4 (2020-09) - Electromagnetic compatibility (EMC) standard for radio equipment and services Part 17: Specific conditions for broadband data transmission systems; Harmonized standard for electromagnetic compatibility • EN 300 328 V2.2.2 (2019-07) Broadband transmission systems; data transmission equipment operating in the 2.4 GHz band; Harmonized standard for access to the radio spectrum • EN 55032:2015+A1:2020 - Electromagnetic compatibility of multimedia equipment. Issue requirements • EN 55103-2:2010 Product family standard for audio, video, audio-visual and entertainment lighting control apparatus for professional use - Part 2: Immunity. • EN 60065:2019 Audio, video and similar electronic equipment Safety requirements. • EN 61000-6-1:2016 – EMC – Immunity for residential, commercial and light industry environments. • EN 61000-6-3:2020 – EMC – Emission for residential, commercial and light industry environments. • EN 60950-1:2014 – Safety of ITE (Information Technology Equipment) • EN 55024:2017 Information technology equipment - Immunity characteristics Limits and methods of measurement. • EN IEC 63000:2018 New harmonized standard to demonstrate RoHS compliance • EN 55032:2015+A11:2020 Electromagnetic compatibility of multimedia equipment - Emission requirements • EN 55035:2017 - Electromagnetic compatibility of multimedia equipment - Immunity requirements | |
| And it is therefore compliant with current directives and regulations. | |
| This declaration of conformity is issued under the sole responsibility of the manufacturer. | |
| Date: 18/09/2023 | Signature:  |
| Place: ANZOLA DELL'EMILIA (BO) - ITALY | |